

TimberTrader

news



Tilling – celebrating 60 years

Page 24

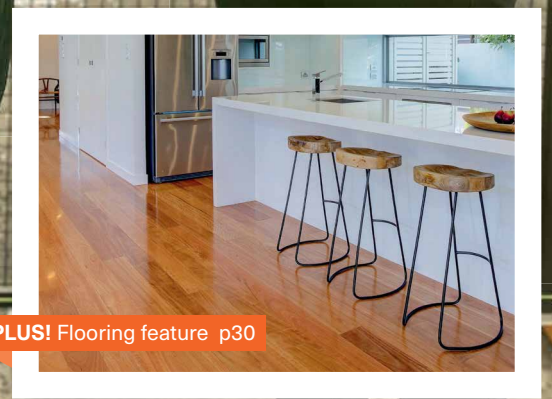

PLUS! Flooring feature p30

PAGE 6
**NIMBLE NEW COMBILIFT
ELECTRIC LIFT**

PAGE 37
**CONNECTORS THAT
MAKE A DIFFERENCE**

PAGE 44
**USING LVL IN TRUSSES:
WHAT YOU NEED TO KNOW**

A Class Act.

For high traffic, non-slip areas like this school mixed-use performance hub, Intergrain® Enviropro® Endure® 2 Pack with *Intergrain UltraGrip®* was chosen as the high performance water based polyurethane coating. It also met VOC requirements of the Green Building Council Australia and P4 slip rating standards.

A gorgeous, protective finish was created that allowed the warmth of the wood to take centre stage.

EnviroPro Endure 2 Pack is;

- Fast to apply
- Environmentally friendly
- Easy maintenance
- Available in Matt, Satin and Gloss



ALBERT PARK PRIMARY SCHOOL PERFORMANCE HUB
ARCHITECTS: SEARLE X WALDRON ARCHITECTURE
PHOTOGRAPHY: PETER BENNETTS

For more information scan the QR code or visit intergrain.com.au/professional-floor-finishes



Intergrain.

TRADE & INDUSTRIAL

©Intergrain, Enviropro, Endure and UltraGrip are registered trade marks.

PUBLISHING DATA

Publisher

John Halkett
johnh@ttnews.com.au

Editor

Donyale Harrison
donyaleh@ttnews.com.au

Editorial Contributors

Paul Davis, George Dolezal, Kersten Gentle, John Halkett, Craig Kay, Afzal Laphir, Peter Maguire, Dennis Neilson and Michael Smith

Art Director

Julitta Overdijk
julittao@ttnews.com.au

Sales and Advertising Director

Campbell McInnes
campbellm@ttnews.com.au
Mob: 0406 223 007

Accounting, Corporate Director & Subscriptions Manager

Chris Parker
cparker@ttnews.com.au

Printer

IVE Group
Unit 1/83 Derby Street,
Silverwater, NSW 2128



Timber Media
AUSTRALASIA

Timber Media Australasia Pty Ltd

ABN: 50 626 345 088
Unit 6, 57 Darlinghurst Road
Potts Point, NSW 2011
PO Box 69, Potts Point, NSW 1335
Tel: +61 (02) 9356 3826
Mob: 0417 421 187

Email: query@timbertradernews.com
Circulation: proprietors, managers and executives in all sectors of the timber and building materials industries including merchants, building material centres, hardware stores, timber window and door manufacturers, truss and frame manufacturers, timber flooring retailers, stair, balustrade and solid timber furniture manufacturers and their associated suppliers and industry associations throughout Australia.

Established October 1985
ISSN 1035/4298
Print Post Approved: 100002694

Email: query@timbertradernews.com
Website: www.timbertradernews.com

Subscriptions for 6 editions:
Australia: \$72 (incl GST) within Australia



Proudly Printed
In Australia

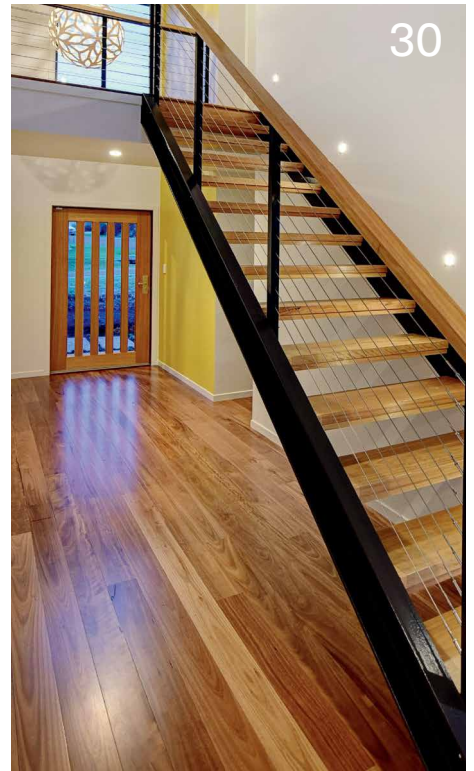

Contents

Industry update

News

NSW forestry at risk; New Combilift electric truck; Housing research shows inner city builds save on infrastructure costs; FIFWA's tree planting day and more..... 4

People business

Stamping out sexual discrimination and harassment at work 16

Association update 18

Features

Tilling at 60

From a young couple with an old Bedford truck to a powerhouse of timber supply and development, The Tilling Group celebrates 60 years of growth and learning..... 24

Woodwise

Timeless Norway spruce..... 28

COVER CREDIT: (From left) Adrian Robertson, Glenn Tilling and Leon Quinn. Courtesy Tilling.
Inset: Courtesy Coffs Harbour Hardwoods.

Timber Trader acknowledges the Cammeraygal people, Traditional Custodians of the land on which this publication is produced, and pay our respects to their Elders past and present. We extend that respect to all Aboriginal and Torres Strait Islander peoples today.

Flooring

For decades of beautiful flooring bringing your home to life, you need to start with the right subfloor. Then the only hard part is choosing from so many glorious timbers 30

Fabricator news

Connectors

New connectors are making it easier to achieve contemporary designs, with suppliers helping builders make safe choices 37

Timber noggins

Watchpoints for using LVL in trusses 44

In the frame

An easy-to-miss standards change could impact two-storey designs..... 46

FTMA newsletter 48

Truss talk

Service loads in medical facilities require special thought. With Paul Davis 50

Disclaimer Unless explicitly stated otherwise in writing, by providing editorial material to Timber Media Australasia Pty Ltd, including text and images you are providing permission for that material to be subsequently used by Timber Media Australasia Pty Ltd, whole or in part, edited or unchanged, alone or in combination with other material in any publication or format in print or online or howsoever distributed, whether produced by Timber Media Australasia Pty Ltd and its agents and associates or another party to whom Timber Media Australasia Pty Ltd has provided permission.



Publisher's note

Norm and Judy Tilling are widely recognised icons of the timber industry. Their business expansion and success now spanning six decades is a testament to their direct, hands-on management style and commitment to their business, and to the industry more broadly. Their son Glenn, now at the helm of the Tilling conglomerate, exhibits many of the management attributes of his parents.

Not only is the company a standout Australian success story, it has now spread its business reach into Asia and

beyond. We are extremely proud to be able to mark the 60 years milestone of Tilling and to be able to take readers inside the measures that have resulted in the stellar success of this Australian timber industry company.

We now have a mini-list of timber supply chain companies wanting to showcase their business success, or a substantial event in their ongoing business story. We invite you to add your company's name to the list by contacting our sales director Campbell Mc Innes (Mob: 0406 223 007).

We are delighted at the number of new subscribers over the last two editions. We acknowledge that this support provides valuable assistance with the climbing costs of producing a hard-copy magazine and getting it into your letterbox. Along with our valued advertisers, subscribers allow us to improve the content and diversity of the magazine.

We would also like to recognise the ongoing contribution to *Timber Trader News* made by timber-related trade associations covered in the Association news section. Trade associations are the industry's litmus test, keeping a finger on the pulse and providing valuable intelligence about current issues and trends. In this regard, we

particularly acknowledge the contribution Kersten Gentle makes in every edition. Not only is Kersten an outstanding chief executive of the frame and truss manufacturers association, but she is more broadly also a pre-eminent communicator across the timber industry. Her section is always a highlight of the magazine – thanks, Kersten.

In addition to our usual insightful columnists this month, we have two significant features looking at flooring (page 30) and connectors (page 37). A common theme running through both is the need to choose products that are right for your conditions. On a related note, Pryda's Adam Dawson says his team is still seeing non-compliant timber being used. Read how the nailplate companies are working together to help reduce this in News (page 8).

Finally, NSW looks to be the next state in line for a battle over native timber forestry (page 5): let's get our forces aligned to win this one.

John Halkett
 Publisher



Timber Media
 AUSTRALASIA

News in brief

First GLT from Timberlink

The new facility at Tarpeena has begun its production.

Good news for the Australian mass timber market: the first GLT (glulam) beam has rolled off the line at Timberlink's Tarpeena facility, just in time for a visit from the South Australian Parliamentary Select Committee.

Politicians Hon. Nicola Centofanti MLC, Hon. Tung Ngo MLC, Hon. Frank Pangallo

MLC and Hon. Ben Hood MLC (plus industry members from across the South Australian forestry sector) were there for the South Australian Forest Products Association's Seed to Structure tour.

The purpose of the tour was to increase awareness around the many stages of

softwood timber manufacturing in South Australia; from seeds in the nursery, to plantation management, to processing and manufacturing finished timber products.

Ian Tyson, CEO of Timberlink, was delighted to host the committee and share this milestone in the construction of Timberlink's NeXTimber manufacturing facility, producing GLT and CLT.

"This is a very meaningful day for Timberlink," said Tyson. "From our first sod turn in February 2022 to producing our first GLT beam in August 2023, we are well on our way to full production, which is scheduled for October this year. It was fantastic to share this milestone moment with the committee."

Timberlink's NeXTimber facility will be Australia's only combined radiata pine CLT and GLT facility, increasing Australia's sovereign capability to manufacture mass timber products while reducing reliance on imports. Mass timber beams are able to cover long spans and have essential uses in both mid-rise and tall timber construction, at a fraction of the carbon cost of traditional steel and concrete construction.

It's a particularly timely accomplishment given the mass of new builds the federal government has just committed to, and we congratulate the Timberlink team!

For more, visit timberlinkaustralia.com.au



The Timberlink team holding the very first GLT beam produced on its newly commissioned line.

Northern NSW forests at risk of closure

Marshall Notaras Timbers in Grafton are fighting council bans.

Donna Layton, general manager at Marshall Notaras Hardwoods, is trying to be polite. "It's not *all* the council," she says, "it's the biodiversity subcommittee that has put this forward, and there are people on the council that don't agree with it, but..."

'It' is a motion to phase out native forest logging in the region that will be discussed at the next Clarence Valley Council meeting in October. The motion was originally put to the June meeting, but held over when it was noted that the local community, including timber businesses, hadn't been consulted. Submissions were called for, but with a closing date of 28 August – and notification on the council website didn't go up till 3 August.

It's left a sense of betrayal among many in the industry. "We're a timber town," says Layton. "Not all the mills are sizeable employers like, us but there are also all the industries that we purchase from: our maintenance, our uniforms, harvesting operators, the freight companies and even local businesses that use our sawmill residues to generate electricity. All of them

would be heavily impacted. It's just unbelievable that our council would even look at doing something like that."

Happily, Grafton and the surrounding region has swung behind their timber workers. "We're getting hundreds of submissions around town," says Layton. "From the pubs, from hairdressers, even people working in offices – all kinds of businesses. We have not had one business say 'We won't sign your

letter of support', instead they've put it on the counter for the local people to sign, too. The response has been incredible. I thought we'd get some flack from some people on the Green side, but no. Everyone knows what it means to have these workers here. Without them, our towns won't survive."

It's an early salvo in a new front of the native forestry wars. *TTN* will be discussing the topic in more depth in upcoming issues, but in the interim you can stay informed about actions like supporting Notaras via our newsletter. Email editor@timbertradernews.com to be added to the mailing list.



The team at Marshall Notaras Timbers (Donna Layton centre, standing, in medium blue shirt).

PHOTO: COURTESY MARSHALL NOTARAS HARDWOODS



STAY SAFE ON SITE!

October is #SafeWorkMonth

Talk to our experienced WH&S Officers about:

- Traffic Management Safety
- Management System Health Checks
- Hazard Identification Services
- WHS Training

Visit ntha.com.au and click on **WHS** or Call **1800 822 621**

national safe
work month

NTHA[®]
NATIONAL TIMBER &
HARDWARE ASSOCIATION



Launched at Ligna, the new Combi-CB70-E is agile and electric.

Nimble, strong and electric

Combilift's new electric vehicle can lift up to 7 tonnes and has been designed with driver safety at front of mind.

Martin Mc Vicar, Combilift CEO and co-founder, was all smiles as he launched the new Combi-CB70E at Ligna back in May as part of the powerhouse Irish manufacturer's 25th anniversary celebrations.

Another in the ever-expanding fleet of electric vehicles from the design-focused lifting specialists, the new Combi-CB70E offers powerful performance, extensive battery life and unrivalled ergonomics. Add

to that it's the shortest 7-tonne capacity counterbalance truck on the market.

Decked out in the new Combi-green livery, the high-capacity Combi-CB70E has an extensive battery life, large super-elastic tyres and a compact wheelbase that together make it ideally suited for the operational demands of the timber industry. Its small footprint and exceptional manoeuvrability mean it can easily move bulky loads around in confined yards and warehouses.

In-cab ergonomics are every bit as important as the CB70E's impressive lifting and movement capability. The spacious cab includes generous glazing for excellent all-round visibility, while the tilting steering column, hydraulic steering and the Grammer MSG65 seat add to comfort. The newly developed Auto Swivel Seat is a patent-pending optional feature that automatically engages and swivels the seat and armrest 15° to the right or left to accord with the direction of travel selected by the operator, reducing driver strain, particularly when travelling in reverse.

The gas strut suspension cab combined with the super-elastic tyres guarantees the smoothest of rides over uneven or less than perfect ground conditions, such as those found in many timber yards. The truck also features Combilift's internationally patented and Red Dot-awarded independent electric traction which provides all front and rear drive wheels with 100% traction control. This negates the need for differential lock on slippery surfaces and significantly reduces long load momentum twisting when travelling sideways. Each electric drive incorporates parking and regenerative dynamic braking for power efficiency. Roll-out access for major electrical components also simplifies maintenance tasks.

Mc Vicar said: "The increased capacities that we are offering in our electric range will answer the demand for ever more powerful products which at the same time help companies to achieve their aims for more sustainable operations."

To learn more, visit <https://combilift.com/combi-cb70e/>



Above left: Martin McVicar launching the Combi-CB70E. Like all Combilift trucks, it specialises in lifting long loads and driver safety and comfort.

PHOTOS: CAMPBELL MC INNES (TOP); COURTESY COMBILIFT (LEFT)

NEW



COMBILIFT 25
LIFTING INNOVATION *Years*

Introducing
**COMBI-CB
70E**

Amazing performance, extensive battery life and unrivalled ergonomics combined with all the advantages of the Combi-CB range make the CB70E the most powerful, compact multidirectional forklift yet.

The new COMBI-CB70E electric multidirectional forklift is the most compact 7,000kg counterbalance truck on the market. Multidirectional ability enables the handling of both long and bulky loads, maximising the safety, storage & efficiency of your logistics.

The CB70E is loaded with a host of ergonomic features that greatly enhance operator comfort, including excellent all-round visibility, a spacious gas-strut suspension cab, independent electric traction and our newly developed Auto Swivel Seat which intelligently swivels 15° in the direction of travel.

Contact Us Today

To find out how Combilift can help you unlock every inch of your storage space.

combilift.com



In brief

The Australian Government has announced of \$5M in funding for a new Australian Research Council (ARC) Training Centre in Plant Biosecurity. FWPA describes the move as 'a key initiative to mentor and train Australia's next generation of research professionals, and to support partnerships between universities and industry that will generate real-world outcomes that are vital to Australia's economic growth'. The ARC Training Centre in Plant Biosecurity will launch an innovative training program for future leaders, with a cohort of graduates innovating in the areas of novel diagnostic technologies, data-driven decision platforms, and addressing barriers to biosecurity adoption. Read the full story at <https://fwpa.com.au/5m-in-funding-for-arc-training-centre-in-plant-biosecurity/>

Listeners to FTMA's podcast (F&T Time) may have heard the recent Running for a Cause ep. Lisa Ottenhaus, lecturer at the University of Queensland and structural timber engineer, is running the Cape 2 Cape in WA with friend Jon Shanks, director of TimberED Services and Associate Professor in Timber Engineering at University of Tasmania. The two are raising funds for MS support and education – Lisa has been living with MS for 13 years. Support them via www.doitforms.org.au/fundraisers/Cape2Cape/jon-and-lisa-are-running-cape-2-cape

NSW Fair Trading and the NSW Building Commissioner now have comprehensive powers to ensure design and building work in Class 3 (shared accommodation) and 9c (residential care facilities) buildings is compliant with the Design and Building Practitioners Act 2020 and Residential Apartment Buildings (Compliance and Enforcement Powers) Act 2020. This will include requiring key design and building practitioners working on these buildings to be registered with NSW Fair Trading and meet minimum standards to be able to continue to work on these buildings. The changes will be phased in, with new build work already subject to the rules and work on existing buildings subject to the new registration requirements from 1 July 2024. For more, see www.fairtrading.nsw.gov.au/news-and-updates/notices/changes-coming-class-3-and-9c-buildings-2023

Easing entry

Demystifying getting new supply into nailplate software.

Adam Dawson, Pryda's marketing and engineering manager, ANZ, has been thinking a lot about new timber supply.

"One thing we are dealing with at the moment is material the industry strongly suspects is of Russian origin that's been re-badged through other countries," he says.

Pryda and the other nailplate companies are being asked to test and include new product in their software to make it available for use in the industry. "We have to rely on importers doing their due diligence of that supply chain and of those origins," he says.

At the same time, they're still seeing issues arising out of some of the more opportunistic supply in recent years. "Anecdotally we're hearing issues of LVLs delaminating quite quickly," Dawson says. "Some of these materials may not have had the proper technical rigour applied to them. And so we're all trying to encourage a really high level of vigilance around particularly engineered wood products to ensure they meet all the requirements to be used and sold in Australia."

Timber Queensland has been doing a lot of education work in this area and now MiTek, Multinail and Pryda engineers are working on



Pryda's
Adam Dawson.

a best practice document to help speed the entry of trusted new supply. "We're applying the exact same process no matter which software you're getting your product integrated into," says Dawson. "Importers will still have to pay for testing, but it will be the same steps to apply for each one and that will hopefully raise the quality and make it easy to verify whether a product has been through that rigour or not, as well as be more efficient."

Tree felling training review

A project reviewing tree felling training is seeking expert input.

Manual tree felling skills using chainsaws are essential for foresters, arborists, emergency workers and more. Currently, training to develop these skills is provided at three levels of competency: beginner, intermediate and advanced.

To demonstrate competence, learners must perform manual tree felling on a specified number of trees. The number required at each level needs to be low enough that it does not present a barrier for training organisations in sourcing the trees, but high enough that learners will be safe

and competent when they take their skills into the workplace. No one wants any surprises when chainsaws are involved.

Some operators have expressed concerns that the current number of trees required at each unit level is impacting their ability to provide training. Skills Insight and ForestWorks are undertaking a project to review the three tree felling units in consultation with industry, considering how many trees are required to demonstrate each skill level and what other mechanisms may be needed to support safety, competence and accessible training.

Input is sought through September then on drafts in October. In devising solutions, consideration will be given to safety standards, accessibility of resources, competency development and training resources.

If you would like to be involved in this project, please contact the project manager, Georgiana Daian at gdaian@forestworks.com.au or for more project details, visit <https://skillsinsight.com.au/projects/treefellingproject/>



Roller Press System



Roller Press System

Integral to your truss-making line, the Preset Roller Press and Finishing Roller have been designed with resilient engineering and smart technology to accelerate truss manufacture.

Rapid Mastery: Train operators within 10 minutes, achieving expert status in just 2 hours.

Swift Automation: Auto bobbins set in a flash, eradicating setup delays. In the time taken to pick up timber from the trolley, the jig has set to position.

Uncompromised Precision: The jiggling is tough and ensures robust handling without fragility, thus enhancing productivity.

Efficiency-Driven Design: The unique flat table design allows effortless plate positioning, boosting operational speed.

Streamlined Truss Removal: Our unique angled ejectors eliminate the need for operator intervention, ensuring seamless truss extraction for maximum efficiency.

Robust Construction, Effortless Operation: Experience heavy-duty construction with easy-to-use controls for unparalleled performance.

Innovative Operator Platform: A table-level operator platform that minimizes table-climbing, making the operator's day easier, increasing productivity, and providing a safer work environment.

Why Multinail?

Made by Australia

Our machinery is built by us, so nobody knows it better.

All parts are locally sourced and delivered fast.

We have a team of 15 experienced service technicians, dedicated to you and your machinery.

Taranaki Base Hospital: shifting expectations of what is possible in sustainable healthcare architecture.



NZ Timber Design Awards

Architects are embracing the challenges of creating low-carbon solutions. By Michael Smith

The return of the New Zealand Timber Design Awards after a three-year absence due to the pandemic has been keenly awaited. Now organised by Timber Unlimited (previously the Timber Design Centre), the awards cover projects completed in the period July 2019 to December 2022.

Debbie Fergie, spokesperson for Timber Unlimited, says determining the finalists across the 12 available categories (some new and others revised) was no easy task. "All entries show innovation, aesthetic appeal, creativity and practicality – made possible through the use of timber," says Fergie.

"It's obvious that the architecture, manufacturing and engineering sectors in New Zealand are ready to embrace the challenges of creating low-carbon timber solutions by incorporating state-of-the-art technology with innovative applications of timber and a variety of engineered wood products."

TE HUHI RAUPO

Prominent in the revised 'Commercial & public building design award' category is the Taranaki Base Hospital's renal dialysis clinic (Te Huhi Raupo), by Warren & Mahoney. The clinic houses 12 dialysis treatment chairs, consultation and training rooms, and a reverse osmosis water treatment plant.

According to the architects, the project's energy-efficient, low-carbon design and use of locally sourced mass timber "shift expectations of what is possible in sustainable healthcare architecture".

The design is a bridge-like structure that utilises a "Woodspan parallel laminated timber (PLT) platform, with driven timber pole foundations and lightweight timber framed roof and wall structure, to span a natural valley between the hospital and a residential street".

The warm and earthy tones of reclaimed Australian tallowwood (*Eucalyptus microcorys*) used in cladding, boardwalk, canopy posts and balustrades "achieve a natural, non-clinical aesthetic with a positive carbon impact".

Meantime, the clinic's interior features a carved American ash reception counter, birch plywood linings and European oak

flooring – creating a warm and welcoming environment for its regular patients.

TE WHARE-ITI

Among the new categories this year is the 'Innovative timber manufacturing & technology award', which focuses on providing design and manufacturing solutions due to advances in technology.

Te Whare-iti: Dorking Road House, by Aonui Architecture, responds to the need for affordable homes to fit diverse buyer requirements. In essence, it is an offsite-manufactured, crane-delivered modular home that uses *Pinus radiata* cross-laminated timber as the primary structure.

Richard Wright, Principal of Aonui Architecture, founded the practice some 20 years ago in response to the growing need and awareness among clients for environmentally responsible and energy-efficient buildings.

"Aligning our designs as closely as possible with natural systems has led to us exploring passive solar design, natural ventilation and low-embodied energy materials over many projects," says Wright.

At a forest conference in 2018 Wright met Marty Verry of Red Stag Timber and learned about the company's soon-to-be-launched cross-laminated timber plant.

That same year, Aonui Architecture was one of six winners (for Te Whare-iti) in the Prefab NZ SNUG house competition, which provided a vehicle for the smart use of CLT in infill housing. Wright sold the manufacturing rights to another related company, Wright Industrial, which now manufactures Te



Te Whare-iti: affordable homes to fit diverse buyer requirements.

Whare-iti modular houses at an assembly line in Porirua, near Wellington.

He says the modular houses are delivered to site by truck and crane 90% completed: "The assembly program for a typical two- or three-bedroom Te Whare-iti is nine weeks – from contract signing to completion at the Porirua OSM facility.

"Trucking and crantage occurs on a single day, and installation on most sites takes four weeks. That time is spent connecting modules to modules, modules to piles, in-ground services, and decks and steps."

Wright adds that groundworks proceed in conjunction with offsite manufacturing. "Sites are prepared by scraping off vegetative surface layers and exposing existing or laying new inground services. Pile depths are determined by geotechnical investigation of often sloping sites, and the piles are then installed in multiples of three to carry the three LVL bearers that underlie every module. They are either standard house piles or round timber poles – encased in concrete.

"Bracing on taller piles is bolted timber. Steel screw piles will be used in any situation where it is impractical to use heavy timber and concrete."

The panel-to-panel fixings are a simple

system of high-performance screws driven by hand tools through the unseen external or strapped internal walls. "Entire walls and ceilings are preserved unblemished, and finished with several coats of linseed oil for a silky, glowing patina," Wright says.

"Joints incorporate a proprietary acoustic tape applied during assembly, creating a pleasing negative detail that is a feature of these houses. Continuing the stripped-back aesthetic, skirtings and architraves are omitted with doors and windows where the monolithic quality of CLT provides a simple attractive alternative."

He notes that a Te Whare-iti OSM house has only 10% of the embodied energy of a conventional onsite-constructed NZ house. "The specific calculation relates to the construction phase – while operational phase figures are not specific to Te Whare-iti, so the BRANZ standard NZ house data has been used," says Wright.

"The expectation is that, with further research and calculation, the carbon footprint of Te Whare-iti will be found to be lower again."

Wright says the post-Covid shortage of standard building materials had minimal impact on Te Whare-iti construction as there



Above: Once delivered onsite, a modular home's connections are completed in four weeks.

is no structural steel or plasterboard used – and very few other products that can't be sourced locally.

"Wool insulation is readily available and always used," he says. "Radiata for the CLT comes from company-owned forests that have an almost endless capacity to provide logs. A typical two-bedroom modular house comprises 24 separate CLT panels. That is a small production run at the CLT plant, which Red Stag advises fits nicely in the pauses between larger projects."

The Timber Design Award winners will be announced at a gala dinner in Auckland on 2 November. For the full set of finalists, visit <https://timberunlimited.co.nz/get-involved/timber-design-awards/2023-timber-design-awards-finalists> T



High pressure treated glulam for proven endurance



Wright Forest Products Pty Ltd
375 Wests Road Werribee VIC 3030
Australia Toll Free: 1800 102 045
www.wrightforestproducts.com.au

wrightforest
products



UPCOMING EVENTS

SEPTEMBER

WOOD YOU LIKE TO KNOW

This online event promises to 'transform the way you approach design'. Multiple streams of panel discussions on topics shaping the future of the industry will be headed by industry experts. Topics include Digital Evolution In The Building Industry: BIM, Robots & Prefab Homes; Unpacking the Latest NCC Changes and Designing for Bushfire Prone Areas. Online expo and networking sessions included, with exhibitors including ITI Australia, Intergrain and Weathertex. Tickets from \$49 for half day live to \$99 for full day and on demand, 28 September, earn up to 10 CPD points.

For more, visit <https://event.woodyouliketoknow.com.au>

OCTOBER

71ST INTERNATIONAL SOFTWOOD CONFERENCE

The conference will offer the opportunity to scrutinise trends in the timber market focusing on facts and figures showing softwood production as well as consumption. Hilton Vienna Park Hotel Vienna, 11-12 October. For more, <https://isc2023.com/>

ANZIF CONFERENCE

The theme for 2023 is 'Embracing Our Natural Capital: the science, technology and art of managing forests for all values'. To be

held 15-19 October Twin Towns Conference Centre, Coolangatta, Qld. See www.forestry.org.au/anzif-2023/

NOVEMBER

SUSTAINABILITY SUMMIT AND AWARDS 2023

Combining the summit, with its topics ranging from the Brisbane 2032 Olympics builds to Designing for Resilience, with the prestigious awards on the second day. 9-10 November, 2023, Sydney and online.

Visit www.sustainablebuildingawards.com.au/#s-summit

Want the full story? Subscribe to the *TimberTrader News* fortnightly e-newsletter via our website www.timbertradernews.com



PHOTO: MATEJ KASTELIC/SHUTTERSTOCK



Renewable. Sustainable. Secure. Reliable.



P: 07 31478790 | E. sales@vidawood.com
 For more information contact: **VIDA WOOD AUSTRALIA PTY LTD**
 41 Inghams Place, Hemmant QLD 4174 Australia



Tree planting day

Industry leaders were digging National Tree Planting Day.

Recently, National Tree Planting Day saw people across the nation getting into the dirt as part of a plan to grow the nation's forest and habitat resources.

Forest Industries Federation (WA) used the occasion to celebrate the fact WA's sustainable forest industries will plant over 8.5 million plantation tree seedlings this season, to cater for record demand for timber and timber products.

Forest Industries Federation WA (FIFWA) CEO Adele Farina said the increase in plantings was a reflection that the plantation industry was thriving, and it was a positive step that government plantings were also increasing. "While we are still heading towards a major shortfall of timber in the 2030s, the increase in plantings is a big step in the right direction," she said.

"Planting now will ensure a supply of timber for future generations, as well as

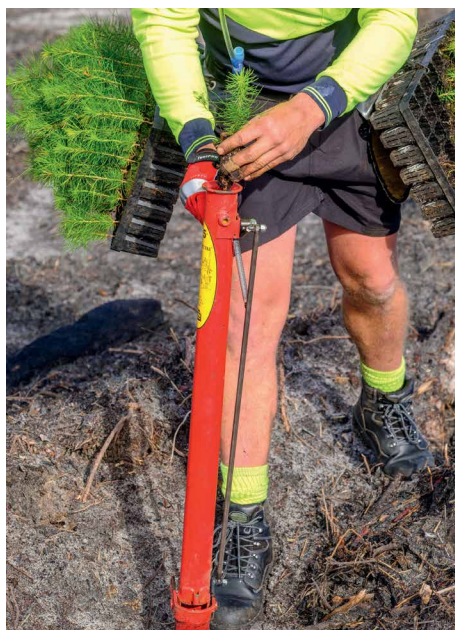

helping fight climate change, providing employment, underpinning regional communities and creating renewable and sustainable products."

For more, www.forestindustries.com.au

NSW housing

Building in and close to Sydney's central business district (CBD) can save up to \$75,000 in infrastructure-related costs per home, new research shows. NSW Productivity Commissioner Peter Achterstraat AM has released *Building more homes where infrastructure costs less*, the second in a series of papers that considers how NSW can use evidence to plan for new homes in the right locations and leverage Sydney's existing infrastructure.

"At least 550,000 new homes are needed across Sydney by 2041. In this housing affordability crisis, it's more important than ever to make sure new housing is built in the right areas and that we make the most of existing infrastructure," Achterstraat said.

"This paper investigates the costs of building across Greater Sydney and finds that the economic costs of growth, varies from \$40,000 to \$114,000 per home, with the lowest cost in areas near the CBD and increasing significantly moving north, south, and west.

"Building up in existing areas is cheaper because much of the necessary infrastructure, such as roads, public transport, schools, utilities, and open space, is already in place. More homes close to jobs also means shorter travel times."

The paper follows the *Building more homes where people want to live* paper, released in May, which tallied the benefits of increasing housing in high-demand areas across Sydney, instead of pushing new homes further away.

"Our previous paper showed the Eastern Suburbs, North Shore, inner city, and Inner West have the greatest unmet demand when it comes to where people want to live. This paper suggests these areas also have the most existing capacity and are the most cost-effective areas to build in," Achterstraat said. "Put simply, more housing in the right places, where people want to live, will improve affordability, reduce infrastructure costs, and limit the burden on taxpayers."

Infrastructure costs considered include road public transport and congestion, schools, water and wastewater connections and more.

You can read the report at www.productivity.nsw.gov.au/building-more-homes-where-infrastructure-costs-less



Above: Outstanding Apprentice of the Year nominees, .

TAFE treasures

Apprentices shine in awards.

Sam Ederveen has been named Outstanding Apprentice of the Year at the TAFE Queensland 2023 Cairns Trade Excellence Awards. The young carpenter recently completed his apprenticeship and works at Brendan Grant Homes.

"Sam excelled during his carpentry apprenticeship training and is a mentor to other trade students, making him a very worthy winner," said TAFE Queensland's Maree Butler.

Other winners included Ashlee Scarcella who was named Engineering Apprentice of the Year and Aboriginal and Kyezaya Namai-Sabatino, the Torres Strait Islander Trade Student of the Year.



From left: Sam Ederveen Outstanding Apprentice of the Year; Kyezaya Namai-Sabatino; Ashlee Scarcella.

Arxada doubles H2F warranty

Already well established as a robust solution for termite protection, Tanalith® Ti is now warranted for 50 years.

Almost 20 years ago, Arxada (then known as Koppers-Hickson) launched its Bluepine campaign with Hyne. The introduction of T2 envelope-treated (H2F-equivalent) framing was designed to push back against the steel industry, which had based the marketing campaign for its own framing products on timber frames being vulnerable to termite attack.

In the decades since, there have been changes and innovations around T2 Blue framing that have made it even more cost-effective and accessible. Now it's not just for high end specification homes, but also for first home buyers.

Tanalith® Ti is one of these innovations and has been used to treat softwood timber framing in Australia for more than 12 years. To date there have been no reported failures of the treated framing in service to attack by wood-destroying termites.

The insecticidal active contained in Tanalith® Ti is imidacloprid. This isn't a repellent in the conventional sense (i.e. molecules aren't continuously emitted from the treated timber surfaces into the surrounding environment), but is as effective a deterrent against termite attack as the synthetic pyrethroids (such as bifenthrin) currently on the market and unlike such synthetic pyrethroids, imidacloprid is non-sensitising to humans.

Recently, Arxada undertook three studies to better understand why imidacloprid is so successful in preventing attack and damage by wood-destroying termites. The results of these studies demonstrate:

1. The stability of imidacloprid in timber 12 years after treatment;

2. The effect of removing treated surfaces from framing elements and subsequent exposure to termites in the field; and
3. The efficacy of imidacloprid in decayed timber material.

STABILITY OF IMIDACLOPRID

All preservative formulations in Australia must be approved by the Australian Pesticides and Veterinary Medicines Authority. H2F envelope-treatment systems are typically approved where efficacy can be demonstrated from exposure to wood-destroying termites, primarily of the genus *Coptotermes*, in field studies. At a minimum the duration of these studies can be as short as four months, but most fall between six and 12 months. Most homeowners would expect the approved treatment system to provide protection for at least the average age of a home – 50 years, if not longer.

Recent studies have demonstrated that Tanalith® Ti has the potential to provide reliable protection for decades. Envelope-treated softwood framing material that had been stored for 12 years under conditions that would typically be experienced by treated framing in service, was re-analysed to determine the retention of imidacloprid in the treated envelope. Results indicated that there had been no significant change in retention over the storage duration¹ (see Fig 1, below).

These results provide strong evidence that Tanalith® Ti will facilitate reliable protection for timber framing for the life of a property. The primary mechanism by which imidacloprid repels or deters attack by termites is via direct contact of termites with the treated timber

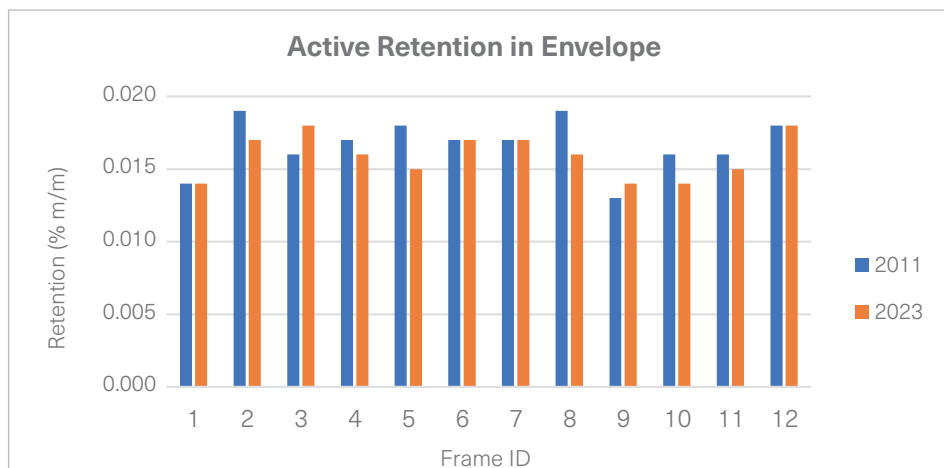

Above: Fig 1. Comparison of imidacloprid retentions in framing samples immediately after treatment and after 12 years' storage.



Above: Fig 2. Example of framing samples with a) notch, and b) drilled hole, exposed to *Coptotermes acinaciformis* in field trials.

surfaces. In contrast, synthetic pyrethroids rely primarily on the regular emission of repellent molecules from the timber substrate to deter termite attack. While effective in the short term, depletion of the active chemicals over time could potentially have implications for their long-term effectiveness in protecting timber framing.

HOLES AND CUTS

On many construction sites, framing has holes bored in it and notches cut for routing of electrical and plumbing services. Frame surfaces are often straightened via planing timber to facilitate even, flat wall faces. Invariably these actions expose areas of non-treated framing which are potentially at risk of attack by termites.

Research studies were undertaken to answer a common question asked by builders and homeowners alike – what happens when the timber is modified, and will the warranty be void if the timber hasn't had a remedial treatment applied to it?

The study undertaken by Arxada² demonstrated that framing materials treated with Tanalith® Ti, with holes and notches cut into their treated surfaces (see Fig. 2, above), remain resistant to attack by termites when exposed in field studies for many months. Taking the study a step further, a comparison against fully treated, untreated and treated pieces with one, two and three surfaces removed were tested and all except the untreated control demonstrated excellent performance against termite attack, regardless of how many faces were removed.

PROTECTING EVEN WITH ROT

House frames under cover are treated for protection against termite attack, because the insects are still a risk even if you have physical gaps to the ground. But because it's assumed

a well-built home won't have issues with water leaks, frames aren't treated for protection against wood-destroying decay fungi, which thrive in elevated moisture environments.

Despite this assumption, leaks can occur within structures. Furthermore, if termites do gain access to a property, they will actively transport additional water into wall cavities in order to maintain an optimum foraging environment. Both scenarios can lead to subsequent decay of timber members. This has the potential to compromise the integrity of framing that has been envelope-treated with insecticides.

In an added risk, wood-destroying termites will preferentially attack decaying wood, as it is richer in nitrogen than sound timber, owing to the chitin and glycoproteins comprising decay fungi. Nitrogen is a vital element for termite health and growth.

In a recent field study conducted by the Arxada R&D team³ to demonstrate the efficacy of Tanalith® Ti, some treated timber samples were observed to have incurred degradation due to attack by decay fungi. However, it was evident that even material



Above: Fig 3. Examples of Tanalith® Ti treated framing samples exposed to *Coptotermes acinaciformis* in a 39-week field trial, a) no decay present, and b) heavy decay present. Both specimens were resistant to attack by termites.

that had suffered mass losses of up to 12% due to decay (see Fig 3, above) were still resistant to attack by wood-destroying termites. It is not clear whether similar observations would apply with synthetic pyrethroids.

Based on these three sets of findings, Arxada

is confident that imidacloprid-treated timber is robust enough to withstand the rigours of time and the effects of common building practices that result in the protective envelope being breached. As a result, Arxada has extended its warranty from 25 to 50 years, meeting the expectations of homeowners around the country. **T**

All information in this article corresponds to Arxada's knowledge on the subject at the date of publication, but Arxada makes no warranty as to its accuracy or completeness and Arxada assumes no obligation to update it. All information in this article is intended for use by recipients experienced and knowledgeable in the field, who are capable of and responsible for independently determining the suitability and to ensure their compliance with applicable law. Proper use of this information is the sole responsibility of the recipient. Republication of this information or related statements is prohibited. Information provided in this article by Arxada is not intended and should not be construed as a license to operate under or a recommendation to infringe any patent or other intellectual property right. All trademarks belong to Arxada or its affiliates or to their respective third parties and are used here only for informational purposes. Copyrighted material has been produced with permissions or under license, all other materials © 2023 Arxada.

[1] Siraa, A (2023). Analytical retentions of active ingredients in H2F treated framing over a 12-year period. Proceedings IRG Annual Meeting, IRG/WP 23-20702, 9 pp. [2] Day K, Siraa A and Lobb P (2011). Termite resistance of timber envelope treated with imidacloprid then modified by typical building site operations. Proceedings IRG Annual Meeting, IRG/WP 11-30570, 7 pp. [3] Hague, J R B and Skewes, B A (2023). The resistance of envelope-treated radiata pine, treated with Vacsol® T and Tanalith® Ti, to attack by *Coptotermes acinaciformis*. Arxada MTC Report 23/11.

arxada

Termite protection for your frame

TRUST

Tanalith® Ti

PROVEN WOOD PROTECTION

TANALITH® is a registered trademark of Arxada or its subsidiaries. ©2022 Arxada

Stamping out harassment

It's time to get serious about stopping sexual discrimination and harassment. **By Peter Maguire**

In December 2022, a new positive duty on employers and persons conducting a business or undertaking (PCBUs) to eliminate workplace sex discrimination and harassment commenced.

The *Anti-Discrimination and Human Rights Legislation Amendment (Respect at Work) Act 2022* (Cth) amended the *Sex Discrimination Act 1984* (Cth), introducing a positive duty on employers and PCBUs to eliminate:

- workplace sexual harassment, sex discrimination and sex-based harassment;
- conduct that amounts to subjecting a person to a hostile workplace environment on the ground of sex; and
- certain acts of victimisation.

Now, employers and PCBUs have a legal obligation to take proactive and meaningful action to prevent all of the above offending behaviours from occurring in the workplace or in connection to work.

This is a big step up from what had been the case when it was a complaints-driven process – action was only required if someone made a complaint after the fact, ie after the sexual harassment had already occurred.

RESPECT@WORK

The Australian Human Rights Commission has established a website with lots of resources to help organisations to learn about sexual harassment and what the new positive duty means, which you can find at www.respectatwork.gov.au.

The first step in the process of exercising your positive duty is to actually understand what the issues are and what your obligations to exercise the positive duty mean in practice. You then need to conduct a risk assessment to ascertain whether there are any risks that need to be eliminated or controlled relative to sexual harassment and the other offensive behaviours noted above.

Figure 1 (right) shows the risk management model published via Respect@Work which is an adaptation from Safe Work Australia's model for managing work health and safety risks.

There are two points with this that are important to note:

- Workers must be consulted at every step in the process and the best results will be obtained by educating and engaging them in the mission to eliminate sexual

harassment from your workplace; and

- This is a continuous process – not something that you just do once and then you have ticked the box. The positive duty means that you must keep assessing risks and the effectiveness of control measures and making necessary adjustments on an ongoing basis.

Please note that sexual harassment also features as one of the psychosocial hazards that Australian organisations are progressively being required to deal with as a workplace health and safety positive duty.

WHAT IS SEXUAL HARASSMENT?

Australian law states that sexual harassment occurs when:

- a person makes an unwelcome sexual advance, or an unwelcome request for sexual favours, to the person harassed; or engages in other unwelcome conduct of a sexual nature in relation to the person harassed;
- in circumstances in which a reasonable person, having regard to all the circumstances, would have anticipated

the possibility that the person harassed would be offended, humiliated or intimidated.

Examples of behaviour that constitutes sexual harassment include:

- inappropriate physical contact;
- intrusive questions about a person's private life or physical appearance;
- sharing or threatening to share intimate images or film without consent;
- unwelcome touching, hugging, cornering or kissing;
- repeated or inappropriate invitations to go out on dates;
- sexually suggestive comments or jokes that offend or intimidate;
- requests or pressure for sex or other sexual acts;
- sexually explicit pictures, posters or gifts;
- actual or attempted rape or sexual assault;
- being followed, watched or someone loitering;
- sexually explicit comments made in person or in writing, or indecent messages (SMS, social media), phone calls or emails—including the use of emojis with sexual connotations;

- sexual gestures, indecent exposure or inappropriate display of the body;
- unwelcome conduct of a sexual nature that occurs online or via some form of technology, including on virtual meetings;
- inappropriate staring or leering;
- repeated or inappropriate advances on email or other online social technologies.

In determining whether an advance, request or other conduct may be sexual in nature, the intention of the alleged harasser is not relevant. An advance, request or other conduct may be sexual in nature even if the person engaging in the conduct does not have a sexual interest in that person or is of a different



Figure 1: The risk management process for sexual harassment.

sexual orientation to the person harassed.

Equally, the behaviour may be unwelcome to a person even if it is accepted or tolerated by others or is part of the culture of the organisation.

As to whether the behaviour offends, intimidates or humiliates someone, that also is a subjective test – it is about how a person perceives and is affected by the behaviour and about how a reasonable person could expect that to happen.

WHAT ARE THE DRIVERS OF SEXUAL HARASSMENT?

There are four key drivers of sexual harassment noted on the Respect@Work website. They are:

1. Condoning of sexual harassment against women (are these behaviours justified, excused or trivialised in your workplace?)
2. Men’s control of decision making in public and private life (how well represented and how much of a voice do women have in management decisions in your workplace?)
3. Rigid adherence to gender roles and stereotyped constructions of masculinity and femininity (in your

workplace, are there any perspectives that some jobs are best done by men and some best done by women?)

4. Male peer relations that emphasise aggression and disrespect towards women (in your workplace, is there a culture of sexist language or jokes or commentary that is disrespecting of women?)

The questions posed above are just a few of those you need to be asking.

THE EXPOSURES

From December 2023, the Australian Human Rights Commission will be able to enter workplaces to inspect them for issues of sexual harassment and will be able to initiate prosecutions and penalties of offending employers.

Workplace Health and Safety authorities around the country are progressively becoming able to do likewise via legislation for PCBUs to have a positive duty to eliminate or control psychosocial hazards.

The Fair Work Commission already had a jurisdiction in which workers could seek orders to stop sexual harassment. As from March 2023, they also have a new jurisdiction where workers can take complaints of sexual harassment and seek compensation.

So, yes, it is time to get serious about stamping out sexual harassment.

For more details and resources for both employers and workers, visit www.respectatwork.gov.au

Peter Maguire is the owner and practice leader of Ridgeline HR, an award winning HRM consulting practice which he founded in 2000. Peter is an acknowledged expert in workplace relations compliance and also a high-performance leadership coach with over 40 years' experience in HRM. Ridgeline HR's byline is Helping PEOPLE in BUSINESS and that is essentially what Peter does – help business people with their people business.





TimberTrader news

GROW YOUR UNDERSTANDING

Every issue, we put key industry issues into context, share new products and techniques and support the people and campaigns that matter. Keep up to date with what's happening in the timber world with a subscription to *TimberTrader News*.

Scan the QR code and subscribe today!



TimberTrader News is the industry's top resource, including sector news, profiles on industry personalities and in-depth features. 12 month subscription (six issues) is only A\$72 and includes GST and postage within Australia. Contact Chris Parker on cparker@ttnews.com.au

AUSTRALIA'S MOST RELEVANT AND INSIGHTFUL TIMBER INDUSTRY MAGAZINE

Association news



ILLEGAL LOGGING LEGISLATION COMPLIANCE UPDATE

As previously reported, since the change of Federal government the Department of Agriculture, Fisheries and Forestry (DAFF) has been more aggressive on illegal logging compliance, and the issuing of infringement notices for alleged non-compliance with the illegal logging legislation.

Along with the Australian Furniture Association, ATIF has expressed concerns about DAFF's recent actions related to illegal logging compliance, the issuing of infringement notices, and actions have been aggressive and disproportionate, causing dissatisfaction in the industry.

In association with legal advice and support, ATIF has identified errors on the part of DAFF in applying the illegal logging regulation.

ATIF is continuing to raise this matter with officials in an attempt to reach a satisfactory outcome. ATIF has also written to the Minister of Agriculture, Senator Murray Watt on this matter. The ATIF Board has considered options to seek legal redress and review. This consideration is ongoing.

SOFTWOOD DEMAND SLIDES

Domestic timber sales data for Australian-produced softwood timber shows a decline of 5.4% over the year ended April 2023, slipping back to 2.9 million cubic metres.

Over the same period, softwood timber imports totalled 775,500m³, down 9.0% from the previous year. Imports may settle within a range of 550-600,000m³ a year over the short term if this trend continues.

Higher than usual stock inventories, coupled with a slower pace of housing construction, climbing interest rates and reduced business confidence have collectively continued to weigh on building and construction demand.

Some importers have noted that present above-average stock inventory levels in the supply chain and in transit are the reason for the recent import volume downturn. However, other timber importers are pointing

to construction challenges expected to continue to be felt in the Australian domestic market, and that look likely to continue into the immediate future.

That said, looking at the medium-term, evidence is starting to point to a moderately increasing level of building activity, and this coupled with disruptions to some established timber import supply chains means that importers and ATIF are looking to reinforce existing supply chains and also develop new sources of supply that are compliant with Australian building codes and other statutory compliance requirements.

FUTURE HARDWOOD SUPPLIES

ATIF is aware that medium-term domestic supplies of high-quality hardwood timber products are likely to be severely impacted by decisions of the Victorian and Western Australian governments to terminate access to native forests for hardwood timber production.

Evidence indicates that these politically motivated decisions will result in the need to source additional supplies of hardwood timber from established Southeast Asian suppliers, plus new potential suppliers in South America and possibly Africa. ATIF continues to be in discussion with current Indonesian and Malaysian hardwood suppliers, and with prospective additional hardwood suppliers elsewhere.

For further ATIF-related information contact John Halkett at: john.halkett@atif.asn.au or 0417 421 187.

*John Halkett
General manager*



ANDY McNAUGHT RETIRES

Australia's timber industry owes recently retired Andy McNaught a debt of gratitude

With the recent announcement of his retirement, the Engineered Wood Products Association of Australasia (EWPA) with the timber industry wish to recognise the long and impactful career of well-known industry stalwart Andy McNaught.

Andy has always been involved in timber processing, starting with his initial study at



Above: Andy McNaught with his wife, Lin.

the forestry school at the Australian National University in Canberra. This was followed by post graduate study in timber engineering at the University of Central QLD.

Andy has spent a total of 47 productive and impactful years in the timber processing sector, with roughly 15 years in drying research in Australia and the USA, another 15 years in plywood and structural softwood mills in a technical capacity, and the remainder in senior management of CSR, Weyerhaeuser and the EWPA.

In his various timber roles, Andy has demonstrated a passion for our renewable industry and products, a true professionalism and a willingness to provide industry operators with the benefit of his expert technical knowledge.

Many within the industry have had the pleasure of working with Andy over the years. His working style has been one of strong collaboration and openness. I personally have appreciated Andy's seemingly bottomless depth of knowledge of our sector, his strong relationships with industry stakeholders, and his ability to navigate across research and policy-making sectors with ease. I know he remains passionate about the future of our renewable sector.

We all hope that he enjoys more time to pursue his many other interests, including mountain biking, renovations, and his family. EWPA joins with the timber industry to congratulate Andy McNaught on his career and wish him all the best for his well-earned retirement.

Gavin Matthew
CEO



INDUSTRY CALLS OUT GOVERNMENT BETRAYAL

Fed up with broken promises, FIFWA is standing with the rest of the state's forestry industry to call out the WA State Government for failing on numerous commitments to industry.

Those commitments include the crucial supplying businesses with the timber they have been contracted to receive, as per former Premier Mark McGowan's promise that current contracts would be honoured to the end of 2023.

FIFWA CEO Adele Farina said an urgent meeting with Forestry Minister Jackie Jarvis had been requested in late July to discuss the matter, however, weeks later at the time of writing, the Minister's office had advised that the request was still being considered and would not provide a timeframe as to when the Minister would provide a response.

We have been told that the Forest Products Commission (FPC) is prioritising the harvesting of firewood over sawlog for the remainder of 2023, leaving businesses expecting their contracted sawlog high and dry. This is contrary to the government's commitment to our industry and supply commitments made by the FPC earlier this year. It is extremely disappointing, particularly for those businesses that have made decisions based on continuing operations until the end of 2023.

Unfortunately, this appears to be yet another in a series of broken promises from government since the decision to end native forestry from 2024. It is both a breach of trust and contract, reflecting poorly on the FPC and government.

Farina has spoken frankly to the industry and media on the issue, saying: "Businesses accepted the government's modest payments, which fell well short of the pre-decision market value of the businesses, on the understanding that their current contracts would be honoured until the end of 2023, allowing them to transition to the new Forest Management Plan (FMP), if they wished to do so.

Unfortunately, this appears to be yet another in a series of broken promises from government since the decision to end native forestry from 2024.

"The decision by the FPC to no longer focus on sawlog production will starve our members of resource and make it impossible for sawmills to transition under the new FMP, forcing them to close before the end of 2023. This means those sawmills will not be there to facilitate the government's ecological thinning program and process timber from mine site clearing.

"The result will be another broken commitment by government, as they will no longer be able to supply local furniture manufacturers with sawn timber as promised."

FIFWA has already shown the flaws in the government's contention that the redirection from sawlog to firewood was due to reduced contractor capacity, as contractors wanting to continue operating were willing to employ skilled workers from exiting contracting businesses in order to maintain capacity.

The redirection was an effort by government to stockpile firewood in the hopes of avoiding supply issues and public backlash next winter ahead, of the scheduled State election.

FIFWA has clarified this to the press, with Farina saying this would likely drive the price of firewood up even further, due to double handling, at a time when families are already struggling with cost-of-living pressures.

"We call on the government to honour its commitment to meet current contractual commitments through to the end of 2023," she concluded.

To learn more on this issue or for FIFWA membership enquiries, contact Beth Johnston at beth@fifwa.asn.au



TIMBER PRODUCT KNOWLEDGE COURSE

MGA TMA in association with Timber Training Creswick (RTOid #4168), have been offering members and industry friends, a timber product knowledge course for a number of years.

The 2-day course is designed for timber and wood product salespeople who need to provide comprehensive advice to customers on the correct timber to use for their applications.

On successful completion of the course, participants receive a Statement of Attainment in FWPCOT3302 Access and Provide Timber and Wood Product Information.

Details are as follows: 1 & 2 November 2023, 9am – 4:30pm (approx.)

Day 1: Suite 5/1 Milton Parade, Malvern Victoria 3144

Day 2: A full day field trip (details provided closer to the date)

Register via <https://www.mgatma.com.au/>

Our 2022 courses were sold out. Register without delay to avoid missing out.

FREDERICK O'CONNELL SCHOLARSHIP

Frederick Richard O'Connell was Executive Director of the Timber Merchants' Association (Vic) in the 1950s. He was passionate about the timber industry and education and in his will, he left a sum of money to be used for scholarships for the children of TMA members or children of their employees.

The intention of the scholarship was to promote industrial harmony in Australia and to improve relationships between employers and employees within the timber industry.

To date, the Frederick O'Connell scholarship programme has awarded over \$1.5 million to worthy recipients. The scholarship lessens the burden on students and may mean they don't have to work as many hours at a part time job. Funds can go towards regular expenses such as accommodation costs and textbooks.

The Frederick O'Connell Scholarship Committee was impressed with this year's strong candidate pool. Our recipients have recently been notified and they represented Dahlsens, Drouin West Timber and Truss, Davids Timber, Bayswood Timber, Lamcal Builders Supplies and Bendigo Truss Plant.

This scholarship is unique and with preference given to candidates who are children of either employees or directors/proprietors of companies who are members of the MGA TMA, it pays to be a member.

If you would like to learn more about the Frederick O'Connell scholarship and other benefits of MGA TMA membership, please contact us on (03) 9824 4111 to discuss.

Marie-Claire McKiernan
National membership manager >>



Above: Dean Wilson, NTHA's Workplace Health & Safety Officer, is focused on traffic management.



Above: Wilson runs many of NTHA's safety workshops, including on chain of responsibility.



TRAFFIC MANAGEMENT FOCUS

October is National Safe Work Month and an opportunity for National Timber & Hardware Association (NTHA) to highlight Workplace Health & Safety (WH&S) priorities for timber and hardware retailers.

Among the various areas demanding attention, traffic management stands out as requiring significant improvements. Addressing the top three WH&S issues in traffic management zones, Dean Wilson, NTHA's Workplace Health & Safety Officer has provided his recommendations to fix common problems and enhance the safety and well-being of workers and visitors alike.

Inadequate signage and markings: One of the primary WH&S concerns in timber retailer traffic management areas is the lack of clear and prominent signage and

markings. Failure to properly designate pedestrian crossings, forklift routes, loading zones, and speed limits can lead to hazardous situations. Insufficient visibility and confusion among workers and visitors contribute to the risk of accidents.

Recommendation: Implement a comprehensive signage and markings program that includes visible signs indicating pedestrian zones, forklift paths, and speed limits. Regularly inspect and maintain these signs to ensure their clarity and effectiveness. Additionally, use floor markings to delineate traffic paths and pedestrian walkways, reducing the potential for misinterpretation.

Inadequate training and communication: Many timber retailers fall short in providing adequate training to their staff and visitors regarding traffic management safety protocols. Lack of awareness and proper communication leads to a higher likelihood of incidents and accidents, particularly when workers and vehicles interact in the same space.

Recommendation: Develop a robust training program that focuses on traffic management awareness and safe practices. All employees, including drivers, forklift operators, and sales staff, should undergo regular WH&S training specific to traffic management. Additionally, establish clear communication channels for disseminating information about any changes in traffic flow or safety procedures.

Insufficient separation of pedestrian and vehicle zones: A major WH&S concern lies in the insufficient separation between pedestrian and vehicle zones within timber retailer sites. This situation exposes workers, customers and delivery personnel to the risk of collisions and injuries.

Recommendation: Re-evaluate the site layout to ensure a clear separation of pedestrian and vehicle traffic. Designate exclusive pedestrian walkways with barriers or physical dividers to minimise the chances of accidents. Furthermore, create safe loading and unloading zones where vehicles can operate without posing a threat to pedestrians.

Prioritising WH&S in site traffic management areas is vital to prevent accidents and create a secure working environment. You can access the NTHA WH&S team's years of experience, formal qualifications, and expertise to assist with practical solutions and advice in understanding your responsibilities and implementing safe work practices.

For more on NTHA Workplace Health & Safety services, visit ntha.com.au and click on WHS.

TDA Timber Development Association
WOODSOLUTIONS TOUR TO SWEDEN AND NORWAY

TDA recently led the WoodSolutions Tour to Sweden and Norway, which had a group of adventurous architects and engineers travelling across Sweden and Norway to view the most advanced timber use. The tour visited sites like a six-storey car parking garage, six-storey apartment buildings erected in three days, robots used to install plasterboard on wall frames, and a city where 50% of all the new buildings were made from timber. The last stop was a whole suburb of eight- to 10-storey timber apartment buildings.

The group also stayed at an 18-storey hotel in Norway, still the second tallest timber building in the world. Another interesting stop was a four-storey building structure made *entirely* from wood. The beam-column connection used wooded dowels, a throwback to the past, and even the timber wall panelling was fixed using timber nails.

Finally, we visited the remaining 1994 Norway Winter Olympics hall – two buildings with 90m and 70m spans. Both buildings are still going strong, and the image on the facing page (bottom right) is a cheeky bunch of WoodSolutions tourists amongst the timber trusses, 37m above the floor

TIMBER OFF-SITE CONFERENCE

Also coming together is the program for the Timber Off-Site Conference on 11 and 12 September.

Speaker lineup includes keynote speaker

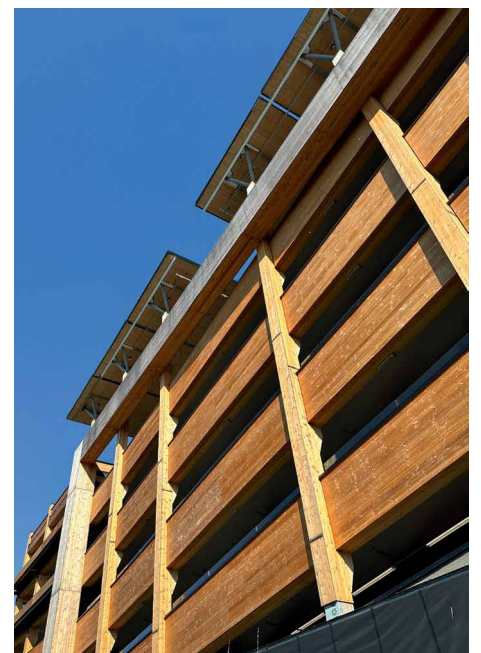

Above: The TDA-led WoodSolutions tour of Sweden and Norway took in a six-storey all-timber parking garage in Malmö, Sweden.

PHOTOS: COURTESY NTHA AND TDA



From top: At 18 storeys, Mjøstårnet hotel in Norway remains the second-tallest timber building in the world. **Bottom Left:** WoodSolutions tourists on top of an 18-storey timber building. **Bottom right:** WoodSolution tourists amongst the trusses at Lillehammer Hall.

Andrew Ball, president of WoW, a leading US vertical integrated construction company leading the trend towards point-supported mass timber buildings. He will discuss how timber saves up to 20% of the costs for his 18- and 25-storey buildings in California.

Many more speakers are on the agenda, covering the design pathway of timber buildings.

ADVANCE TIMBER FRAMING CENTRE

TDA proposes that an Advance Timber Framing centre be created to push the use of lightweight framing. Significant volumes of timber framing are used in the housing market, which means the timber industry is highly dependent on and always has to respond to fluctuations in housing demand. Numerous other building applications, similar in size to housing, can also benefit from using timber framing. Builders, fabricators, and regulations prefer prescriptive building regulations to efficiently and economically

access these other building applications.

An issue with current prescriptive building regulations is that they are limited, making it challenging to incorporate timber framing solutions beyond these geometric limits, i.e. two storeys.

Another important issue is that our major competitor, steel framing, has caught up to and, in some areas, surpassed timber framing in market acceptance. This situation has resulted in the choice between steel or timber framing being based on price or availability. In the past, timber framing was the go-to choice for project builders because it had features beyond steel framing, mainly due to the ease of building regulation compliance and the unnecessary need for engineer's certification. This position has now changed and poses a significant market threat.

A substantial update is urgently required to overcome these limitations and place timber framing ahead of steel framing. The following describes this project's aims.

The Timber Off-Site Conference is coming together.

Project broad aims.

1. Extend the range of lightweight timber-framed prescriptive solutions beyond just houses.
2. Change the prescriptive solutions to load-based solutions, removing applicable base solutions.
3. Extend the envelope size of timber framing prescriptive solutions, including three storeys and open plan.
4. Increase applications of low-strength or value, sawn timber, or underutilised fibre.
5. Increase acceptance of engineered wood products.
6. Digitise design methods, ideally develop acceptance for referencing industry proprietary software in building regulations.
7. Develop points of difference to steel framing, placing timber framing as the preferred material.
8. Start the 'succession' process and transfer knowledge from the 'old guard' to the next generation of industry timber technologists.

Andrew Dunn
CEO



NEW LAW COULD COST PLANTATION GROWERS MILLIONS

A new Federal Government amendment bill could have dire unintentional consequences for Tasmania's forest plantation estate growers and managers.

The proposed *Treasury Laws Amendment (Making Multinationals Pay Their Fair Share—Integrity and Transparency) Bill 2023*, if passed by the Federal Parliament, will have a significant and detrimental impact on the forest plantation estate in Tasmania, as well as across Australia.

We know the economic returns of plantation forestry are already lower than other agricultural commodities, which has resulted in a reduction of the national plantation forestry estate. And, if the Bill passes without amendment, this financial difference will be exacerbated.

Under the current law, forestry plantation companies can claim up to 60% of their >>

debt costs as a tax deduction. However, under the changes proposed in the Bill, many will be unable to claim any of their forestry plantation debt costs as a deduction.

And where companies are actually able to claim their forestry plantation debt costs, it will be significantly less than the current 60%. It's a complex change, but one that could have a devastating impact.

Put simply, it will mean a huge economic impact for our plantation businesses, the regional economies where they are based, and the thousands of Tasmanian families who directly work in the industry.

As highlighted in the Australian Forest Products Association submission to the Economics Senate Standing Committee, if the Bill passes without amendment, it will:

- Reduce investment in plantation forestry;
- Reduce the profitability of plantation forestry companies;
- Penalise the expansion of the forestry estate for current pine species; and
- Disadvantage any plantation forestry company seeking to establish long rotation hardwoods.

The Bill will cause the Tasmanian plantation estate to shrink further, resulting in a reduced supply of timber on the Tasmanian market to cater for the increasing housing demand, inhibiting Australia's capacity to respond promptly to the global threat of climate change and limit options to farmers to offset their agricultural greenhouse gas emissions.

While the TFPA has no issues with the intention of the Bill (making multinationals pay their fair share), we believe that plantation forestry companies were never the target of this policy.

Many of the plantation forestry companies who will be impacted by this change have both local and international investors. Many of the local investors are Tasmanian forestry families themselves. These local companies are critical in providing investment to build sovereign capability for our industry.

In Tasmania we have a small number of plantation forestry companies, and because of the unique nature of the sector, plantation forestry companies may be impacted through an oversight in creation of the Bill.

We firmly believe that the capturing of forest growers is inadvertent as our members are businesses that reside in Australia and pay tax in Australia with both national and international shareholders. The TFPA will continue the fight to protect our unique, local industry and ensure laws like this will not unfairly target our businesses.

Nick Steel
CEO



UNDERSTANDING UNFAIR DISMISSAL

TTIA is regularly asked by Members to give advice on situations where termination of an employee is the only option. In these circumstances, the employee will only be able to access unfair dismissal remedies if they meet all the eligibility criteria, and the dismissal was harsh, unjust or unreasonable.

Relevant factors to 'harsh, unjust and unreasonable'

Factors that are relevant to whether a dismissal was harsh, unjust or unreasonable are specified in s387 of the Fair Work Act 2009 (Cth) and must be taken into account by the Fair Work Commission in unfair dismissal claims.

Relevant factors include:

- **Valid reason for dismissal:** whether there was a valid reason for the dismissal related to the person's capacity or conduct (including its effect on the safety and welfare of other employees). This valid reason should be sound, well founded and defensible;
- **Notification of the reason:** whether the person was notified of that reason;
- **Opportunity to respond:** whether the person was given an opportunity to respond to any reason related to the capacity or conduct of the person;
- **Support person:** any unreasonable refusal by the employer to allow the person to have a support person present to assist at any discussions relating to dismissal;
- **Prior warnings:** if the dismissal related to unsatisfactory performance by the person – whether the person had been warned about that unsatisfactory performance before the dismissal;
- **Size of the enterprise:** the degree to which the size of the employer's enterprise would be likely to impact on the procedures followed in effecting the dismissal;
- **HR expertise:** the degree to which the absence of dedicated human resource management specialists or expertise in the enterprise would be likely to impact on the procedures followed in effecting the dismissal;
- **Any other relevant matter:** any other matters that the Fair Work Commission considers relevant.

What else?

The Fair Work Commission has broad

discretion to decide what is 'any other relevant matter' in an unfair dismissal claim. In past cases, the Fair Work Commission has balanced the seriousness of the reason for dismissal against:

- the employee's length of service,
- employment history (e.g. including whether they have had a clean disciplinary or performance record);
- the employee's ability to find other employment following dismissal (including their age, any illness/injuries etc.);
- the employee's personal financial situation (i.e. whether they have dependants, a mortgage etc.).

It is therefore critical to consider the employee's response to any proposed dismissal to determine the likelihood of any unfairness.

What about serious misconduct?

Even though an employee has committed serious misconduct, they can still be eligible to make an unfair dismissal claim.

While the employee's conduct may justify instant dismissal from your point of view, it is important to first take into account the employee's responses, the whole of the circumstances, and the weight of evidence before making a final decision. This is because an instant dismissal may be harsh, unjust or unreasonable (and potentially an 'unfair dismissal') if:

- the outcome is disproportionate to the gravity of the misconduct (including consideration of the employee's personal or financial circumstances).
- the employee did not actually commit the misconduct.
- there is insufficient evidence to support the employer's conclusions.

If you have reasonable concerns about an employee being in the workplace during an investigation of potential serious misconduct, you may be able to suspend their employment. Please contact the TTIA before suspending employment.

Contact us for more information and assistance

TTIA is the key national Association that assists employers with handling performance and conduct issues, dismissal processes, responding to unfair dismissal claims, and can provide representation in the Fair Work Commission. **For further information about unfair dismissal or our services, contact the National Timber Employers' Hotline on (02) 9264 0011 or by email: ttia@ttia.asn.au**

Brian Beecroft
CEO

Partner with AFP and be confident
all our timber is ethically sourced, compliant
and fit for purpose



AFP are wholesale distributors of
Metsä Kerto LVL and Finnjoist products



Kerto® LVL

Finnjoist
I-beam



LIGHTER... Our Kerto LVL is half the weight of our competitors

STRONGER... Our Kerto LVL & Finnjoist is batch tested every hour of production

GREENER... Every stick is traced back to the tree from where it was harvested

FASTER... Complete floor systems direct to site in 24 hours

PHONE: 1300 255 433





Tilling at 60

From starting on a £400 loan to one of the leading timber companies in the country, Tilling's journey has had the constant goal of delivering value for the industry.

Tilling's recent birthday celebrations were a family affair in the very real sense of the phrase. Whether bound together by blood or by years of working for a common goal, the Tilling family reminisced over the journey that has taken the company from its two-person start to national prominence in the timber sector.

Here, based on speeches given at the celebration by managing director Glenn Tilling and CEO Adrian Robertson, is a brief recap of that journey.

THE START OF TILLING

It began, as many good stories do, with two young, vibrant and very ambitious newlyweds. He was a very eager young sales

rep named Norm from a rickety old timber yard called PGA Timber. With a solid track record of selling timber to builders all over eastern Melbourne, he hoped for a good response when he asked for a pay rise as he and his beautiful bride, Judy, were expecting their first child. Instead, he met a flat no.

Glenn imagines that Norm said to that: "I know! Even though I have a very pregnant wife and a half-finished house to be completed, I'll quit my secure weekly paycheque and go out on my own! How hard could it be if these clowns can do it?"

A family friend was able to lend them £400 and Norm and Judy began sourcing OB hardwood scantlings from Alex Demby sawmills in Toolangi and Brimbonga

Sawmills in Warburton, machining the timber at night at a local joinery shop and selling it from under said half-finished house in Eltham to local builders. And just like that N&J Tilling was born.

From there it was mostly growth: around 1964 they took over that local joinery shop and bought a truck – "An old Bedford without a working park brake and gear stick that would only stay in reverse if firmly held in place, which was my mother's job with my then baby sister, Peta, on her other knee," says Glenn.

With the purchase of an old Wadkin Moulder and a 48-inch Robinson band saw, Norm and Judy started running V-joint and channel profiles; soon Tilling was synonymous with high-quality, on-trend profiles of western red cedar and other exotic timber species from around the world.

The natural next step was into the sphere Tilling remain famous for: understanding the direct import market. They hoped to bring in



Snapshots from Tilling's history including Norm and Judy through the years, the old red Bedford Truck, the Eltham site, including the sawdust hoppers, Craig Kay (left in the bottom right photo) and the new I-joist plant at Kilsyth.



The move from Eltham spring-boarded another growth period.

they didn't see the funny side of it.

"A few weeks later, Norm was telling the Ford car dealer next door, 'Sorry about your flattened cars, mate, but I did tell you to move them away from the fence when it rains. Hey, do you reckon the boys could bring the fork around so we can pick up our 40-foot flitches? I'm sure your brand-new Roller is under there somewhere...' Needless to say, N&J Tilling had outgrown the newly gentrified, artsy, suburban Eltham."

The move from Eltham spring-boarded another growth period for Tilling: the company moved to its new (and still current) head office site in Kilsyth in 1978 and greatly expanded its offering of WRC Architectural products and cut to size Oregon.

It was a vibrant time, with Melbourne undergoing a building boom in the late 1970s and early '80s and Tilling being one of the few companies with guaranteed supply through the mill strikes of the late '70s. "These crippled the supply volumes of the long-established exporters and importers such as MacMillan Bloedel, Seaboard and Gunnerson's," says Glenn. "We had desperate, wood-starved merchants saying, 'Norm, we don't care what the price is and so what if the wood is crap? Just put it on a truck!' Which sounds familiar from more recent years."

The business changed its name to Tilling Timber and in the early '80s opened wholesale yards in Wetherill Park in Sydney and Springwood, Brisbane. Still very much a family business, with Norm managing manufacturing and operations, and Judy sales and marketing, it was now a bigger family with daughters Janelle and Peta and son Glenn.

The focus remained on sawn wood in those days and Tilling took a leadership position around imports, hosting a four-week West Coast study tour with around 30 customers visiting Oregon, Washington State and Vancouver sawmills in 1984. As Glenn says, "They drank the entire city of Portland dry of red wine!"

A SHIFT IN FOCUS

In 1986, Tilling opened a shipping and logistics support office in Portland then, in 1988, a small agreement heralded a big change. Tillbeam Glulam was the company's first EWP offer, and the agreement to

cedar and Oregon from the West Coast of the US and Canada themselves and thereby lower their costs as Australian wholesalers were eating their margins. At that time that market was a closed shop, with the 'Vancouver Club' controlling access.

Undeterred, Norm and Judy boarded a Qantas 707 at the newly opened Tullamarine Jetport and began the multi-leg journey to Vancouver. Once there, they knocked on a lot of doors and received a lot of versions of the same lecture about the trading arrangements being long-established and not the sort of thing anyone wanted to upset. They were told to go home and stop bucking the establishment.

Instead, they kept knocking until a few of the smaller cedar and Douglas fir mills agreed to supply them, which began Tilling's decades-long position of strong supply within the market.

Around 1970, Norm and Judy were approached by some progressive Eltham

architects about making cedar panelling and mouldings. Their clients were inspired by Modernist American architects such as Frank Lloyd Wright and there was a growing demand for western red cedar wall panelling as shown in *American Home Beautiful* type magazines. Things were going well.

But, as with every good story, there were bad days.

The old sawdust hopper had been struggling to keep up for a while and one day it simply went *boom*, with an explosion of cedar sawdust all over Tilling's neighbours along the road.

Glenn takes up the story again: "One of those neighbours was our soon-to-be-ex friends at Kookaburra Cricket – they had just put a fresh batch of newly lacquered balls out in the sun to dry ready for the upcoming summer of cricket. Norm told them, 'Don't worry, you can always sell them as red ornamental lamingtons!' He still to this day doesn't understand why

market it in Australia was entered into as part of a package: the real goal was the attached exclusive local rights for all Bohemia Douglas fir volume.

For a few years, EWP remained a small part of the offer, but that was soon to change, as was the way the company operated: Judy focused on the import operations including due diligence while Norm concentrated on sales and marketing.

In 1990, Tilling opened its Newcastle/ Carrington Wharf bulk receiving yard and in 1993, Willamette Industries bought out the Bohemia Lumber company, inheriting the existing supply agreement to supply Tilling with Douglas fir and glulam. The following year, Tilling became the exclusive distributor of Willamette LVL and I-joist and the year after that, the company launched the SmartFrame brand.

1995 was also the year that national engineering manager Craig Kay joined Tilling Timber, along with a small team of detailers, offering floor system estimating with the then newly created SmartFrame design software. "Fast-forward nearly 30 years and we now have 33 detailers and three engineers across Vietnam, Brisbane and Melbourne, with over 26,000 design requests resulting in some 14,000 unique designs per year," says Glenn. "It's the largest design service of its type for the Australian market."

By 1999, the Portland shipping office was no longer needed as the market had shifted so strongly away from precut Oregon towards EWP. The year after it was closed, Tilling was appointed exclusive distributor of FinnForest LVL for Australia, where it sold under the SmartFrame brand. A year later in 2001 Tilling became the east coast distributor of Wesbeam LVL, which was also made under the SmartFrame brand.

Not every New Year began with a high point. In January 2002, American timber giant Weyerhaeuser signed a merger deal with Willamette Industries and Norm and Judy were unable to secure ongoing distribution. Undeterred, the Tillings went to Seattle to meet with Pacific Wood Tech who went on to become the company's major EWP supplier for the next two decades. That same year, Tilling signed an exclusive distribution agreement with Nelson Pine LVL.

If 2002 began with a problem, 2003 ended with a catastrophe. On New Year's Eve a huge fire raged through the Kilsyth facility, destroying the office and moulding mill and causing some \$5 million in damage. More than 130 firefighters and 43 appliances were needed to put it out and the fire cut local electricity and robbed the suburbs of Kilsyth and Montrose of drinking water for the following couple of days.

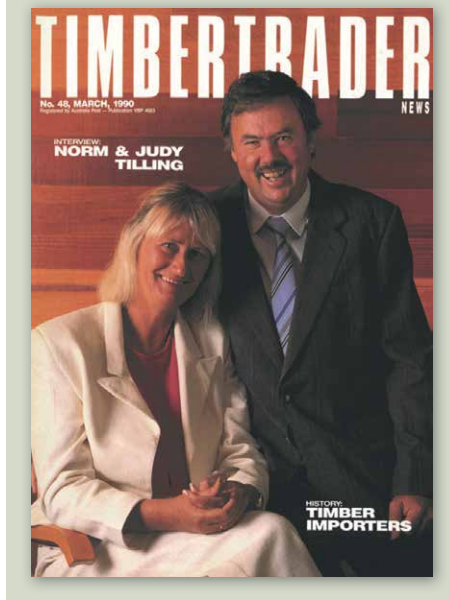

Judy and Norm Tilling's accomplishments were the cover story for TTN Number 48 in March 1990.

Yet true to form, Norm, Judy and Tilling Timber bounced back. On 1 December 2005, then Premier of Victoria Steve Bracks opened the new and improved offices and the adjoining (and fully sprinklered) warehouse at Kilsyth.

"The years after the fire heralded new accomplishments," Glenn says. "We launched a series of new products, moved into Perth, celebrated our 50-year anniversary and opened in Adelaide, where we quickly outgrew our original site and relocated to an old Holden car seat factory."

Glenn says they were a series of very good years, adding that in 2017, Richmond even managed to win the AFL Grand Final!

CHANGES: PLANNED AND OTHERWISE

Then in October 2019, Norm had a life-threatening stroke. He survived, but immediately retired from his active roles in the business. Judy stepped back with him, but has continued to provide the wider industry with the benefits of her expertise on issues around importation, supply and market changes.

By then, the second generation of Tilling Timber was well established. Glenn had been active in the business as a director for more than 20 years and a strong management team on both the business and engineering sides had been keeping the wheels turning smoothly for Norm and Judy, so the transition was comparatively painless.

The times, however, were anything but. The Coronavirus Pandemic and the then Federal Government's HomeBuilder stimulus package combined for a once-in-a-lifetime timber shortage.

No sooner was shipping starting to get back to something approaching normal than

Russia invaded Ukraine in February 2022. FSC and PEFC declared all timber from Russia and Belarus to be Conflict Timber. With remarkable speed, Tilling moved the entirety of what had been Australia's largest LVL supply chain out of Russia and into Asia, and worked carefully along that chain to make sure it was free from falsely labelled conflict timber.

Although unexpected, the shift into Asia has come with benefits. In September last year, Tilling opened a representative office in Ho Chi Minh City, Vietnam, where 30 highly skilled and dedicated staff provide back office support services including SmartFrame design and administration support. Additionally, a new Vietnamese outsourcing business, MyTeam, now provides remote staff for the building supply, construction and associated businesses. This allows for Tilling to be supported in a challenging job market, but also delivers the same opportunities to its partners.

One planned-for change was the commissioning of a custom-built, state-of-the-art I-joist plant at Kilsyth with full production earlier this year. Once again, the company is taking a leadership role in ensuring supply.

From two people, Tilling now numbers just over 200 staff across Australia and Vietnam. Where once there was a small range, now it is a leading Australian supplier of EWP and has led the way in changing the industry, whether that be from comprehensive IT services that have now grown from engineering designs to adding value across each customer's whole business, or in championing new building methodologies such as cassettes.

"The credit is with Norm and Judy for building a company based on hard work, strong investments, pioneering innovation and strong family values," says Adrian Robertson.

"And while we celebrate the past, we've been investing to strengthen ourselves and our customers for the future. We've commissioned the largest timber treatment facility in Australia up in Queensland, which will allow us to bring innovations in treatment that have never been seen before. The SmartJoist manufacturing currently being commissioned in Victoria will bring manufacturing back into Australia and shorten the length of the supply chain, plus our large IT investments will expand what we can offer our customers in terms of live opportunities.

"The past is something to be proud of and the future is exciting!" **T**

For more, visit www.tilling.com

Made in
Australia.



Ask your Tilling representative about SmartRewards,
for builders purchasing SmartJoist floor systems!



For SmartJoist Floor Systems

SMARTFRAME[®]
POWERED BY INNOVATION

Email plans to:
smartdata@tilling.com.au





Above: Norway spruce extends across northern Europe up into the Arctic Circle.

Woodwise: Norway Spruce

From Christmas trees to Stradivarius violins – the versatile Norway spruce.

Norway spruce is the classic Christmas tree. As a thank you for wartime help, the City of Oslo donates one each to London and Washington DC every year, which are erected in Trafalgar Square and Union Station respectively. Its role as a holiday centrepiece is not, however, the primary reason why this tree endows us with some of our most moving moments – that is its ‘tonewood’ which is used to make the soundboards of the world’s most valuable string instruments.

Often found at altitude, in poor soil and low-temperatures, Norway spruce grows slowly after its first 25 years. The resulting older wood is strong and rigid, giving instruments a more sonorous tone. The most special guitars, violins and cellos – musical



Above: Stradivarius violin soundboards, made from Norway spruce sourced from the Italian Alps.

instruments that delight audiences around the world for their incomparable quality of sound – all have soundboards of slow-growing Norway spruce.

Other names: Nordic whitewood, Baltic white pine, white Deal, European spruce, Finn spruce, Romanian whitewood, white fir, white spruce, violin wood, and Carpathian spruce

Botanical name: *Picea abies*, with abies meaning ‘like a fir tree’.

CHARACTERISTICS

Norway spruce is a fragrant, pyramid-shaped conifer with a greyish-brown, scaly trunk and long, cylindrical cones, it is a large tree, growing to 35-55m tall with a trunk diameter of 1-1.5m. It can grow fast when young, up to a metre per year for the first 25 years under good conditions, but becomes slower once over 20m. The leaves are needle-like with blunt tips and dark green on all four sides.

The native range of Norway spruce includes a swathe of Northern Europe – from the Arctic edge of Norway in the northwest and as far as Russia eastward to the mountains of central Europe, southwest to the western end of the Alps, and southeast in the Carpathians and Balkans to the extreme north of Greece.

APPEARANCE

The sapwood of Norway spruce is white to pale yellow in colour, its heartwood is not

always distinguishable but often tinged with brown and reddish-brown hues. Growth rings are prominently marked by the darker, denser summerwood. The grain of Norway spruce is relatively fine, and typically straight. Knots are clustered together rather than randomly distributed. Timber surfaces often exhibit a slight lustre.

COMMON APPLICATIONS

When harvested young, the timber of this species is flexible and durable. Its relative lightness, long length and straightness make it ideal for telegraph poles, wooden ladders, oars, roofing timbers and paper pulp. Construction grades are commonly used for non-structural applications such as flooring and cladding, inexpensive furniture, joinery and general carpentry.

Top-grade Norway spruce is a premium tonewood prized by luthiers for its acoustic properties; it is a timber of choice for acoustic guitar soundboards.

When the luthiers Stradivari and Guarneri needed tonewood for their violins they used Norway spruce from the Italian Alps. One reason why the 17th and 18th-century instruments are so special is that they were made using wood that grew during the ‘Little Ice Age’ that began in the early 14th century and lasted until the mid-19th. During this period Norway spruce trees lay down exceptionally narrow annual rings leading to very stiff and consistent tonewood – the foundation for the golden age of violin making.

WORKABILITY

The timber of Norway spruce is flexible and durable. It glues satisfactorily using standard bonding procedures. However, it can give poor results when being stained due to its closed-pore structure. A sanding sealer, gel stain or toner is recommended when colouring Norway spruce. It is a resinous timber, and its sawdust is reported to cause skin irritation and respiratory problems among some users. **T**

Further information: Content based in part on Wood Solutions website. For further information see: www.woodsolutions.com.au/wood-species/softwood/spruce-norway

PHOTOS: (TOP) ADAMIKARL/SHUTTERSTOCK; (BELOW) ANNA SHKOLNAYA/SHUTTERSTOCK

One source.
Many resources.

Forest & Wood Products Australia
Growing our industry together.



meySPAN

STRUCTURAL LVL

LEGAL SUSTAINABLE COMPLIANT

meySPAN13 meySPAN14 meySPAN15

**LEGAL
SUSTAINABLE
COMPLIANT**

**“The three things you
don’t need to worry about.”**

To learn more about meySPAN and our procurement safe guards, please contact your Meyer Timber® representative.



www.meyertimber.com.au

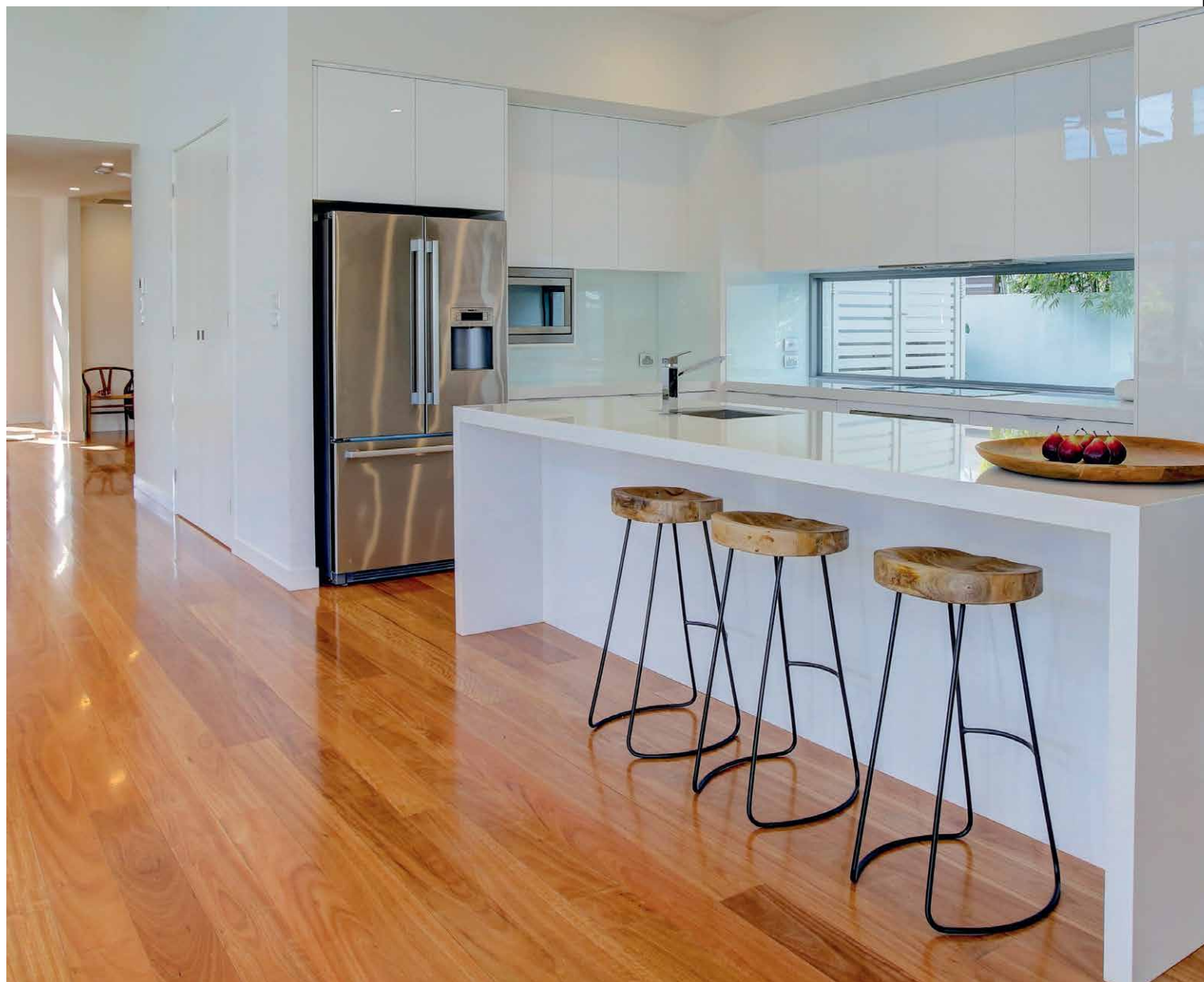

From the floor up

Beautiful, lasting floors start with materials fit for the conditions. **By Donyale Harrison**

We often do things arse-backwards when it comes to floors. In a country with some of the most beautiful flooring timbers in the world – and some of the most diverse climatic conditions – the homeowner is encouraged to choose their preferred floor coverings and given detailed information on how each option can perform, while the builder usually constructs the subfloor however they want and passes little or none of that information on to the owner.

“The homeowner just doesn’t know why all this matters and what’s available to them,” says Greg Muir, Queensland sales manager at Australian Panels. “Whereas if the builder said to them ‘OK, so you’re in a damp zone

and the number one risk to your floorboards is going to be from constant high humidity, here are your options for tackling that...’ then 99% of owners would be happy to spend a little extra money upfront to stave off a wave of future problems.”

Ryan McCarthy, sales and marketing manager at Coffs Harbour Hardwoods, works at the floor covering end of the equation, but he couldn’t agree more. “There are so many factors that affect flooring installations, and they start long before you buy the floor and last all the years you’re living with it,” he says.

“We’ve spent a lot of time educating our installers and our customers, and we see good results coming out of that. But builders

aren’t always thinking about what comes next when they’re making their choices about subfloors, boards and ventilation.”

It leaves flooring suppliers in a fix: with a huge range of solid floors, engineered boards and parquetry that deliver exquisite, long-lasting and value-adding finishes to a home, they’re often at the mercy of the preceding trades when it comes to the conditions their products will be laid in.

Which makes it more important than ever that homeowners, retailers and suppliers all understand the needs of contemporary flooring products and push for a systemic response to the conditions from builders. Happily, it’s a beautiful job...

“Our solid 19mm tongue and groove flooring is made from the highest quality hardwoods, and is perfect for high traffic areas.”

from the highest quality hardwoods and gets a lot of product out of that timber resource.

“We have a comprehensive focus on quality: not just with the boards themselves, but also with how they are installed and maintained after laying.”

CHH produces detailed publications for its installers that are mini masterclasses on timber flooring’s characteristics and requirements, including future sanding, coating and upkeep guidance.

“They take effort to write up, but it’s well worth it,” says McCarthy.

“For us, flooring isn’t just a one-off sale: it’s a broader process that forms a central part of people’s homes, so we concentrate on getting all parts of that process right.”

This process starts with the careful selection and sustainable harvesting of hardwoods, which are processed locally. CHH’s showroom is a timber-lover’s delight, with a range of boards and parquetry set out on the floor and walls so builders,

homeowners and designers can walk on and touch the product with ease – no wonder it was voted ATFA Excellence Showroom of the Year for Australasia 2023 by the members of the Australasian Timber Flooring Association.

“Again, that took commitment to deliver, but there’s nothing like physically standing on your potential floor,” McCarthy says.

“And it’s a real benefit to our sales team, because they’re not just asking people to rely on their expertise when it comes to helping them choose the right product for their needs, they can show them the differences between their options.”

CHH delivers a lot of options, including solid 19mm tongue and groove flooring, 13mm overlay flooring, stadium sports flooring, and a parquetry range comprising both block and mosaic finger parquetry.

“Our solid 19mm tongue and groove flooring is made from the highest quality hardwoods, and is perfect for high traffic areas,” says McCarthy. “For families or »

Solid 130x19mm Select Grade Blackbutt Tongue & Groove floorboards from Coffs Harbour Hardwoods deliver a warm finish.

HARDWOOD SPECIALISTS

McCarthy is on his way back from a sports stadium when we talk. It doesn’t sound like the natural home for a hardwoods specialist, but he’s been speaking with the owners about their floors.

Turns out that stadium floors have very different requirements from homes. “We mill the boards to a narrower profile,” says McCarthy. “This product is produced at 60 x 20.5mm, which is smaller than most of our range. The narrower boards are ideal for stadia as they have limited movement compared to wider boards. This makes them perfect for high-impact use in gyms, schools, and other sports facilities.”

It’s not a surprise to learn that Coffs Harbour Hardwoods (CHH) counts sporting facilities among its customers: the business is a leading supplier of hardwood flooring across Australia, in addition to its other ranges, from decking and cladding to posts and poles.

“We’re very proud of our flooring offer,” says McCarthy. “It’s sustainably produced

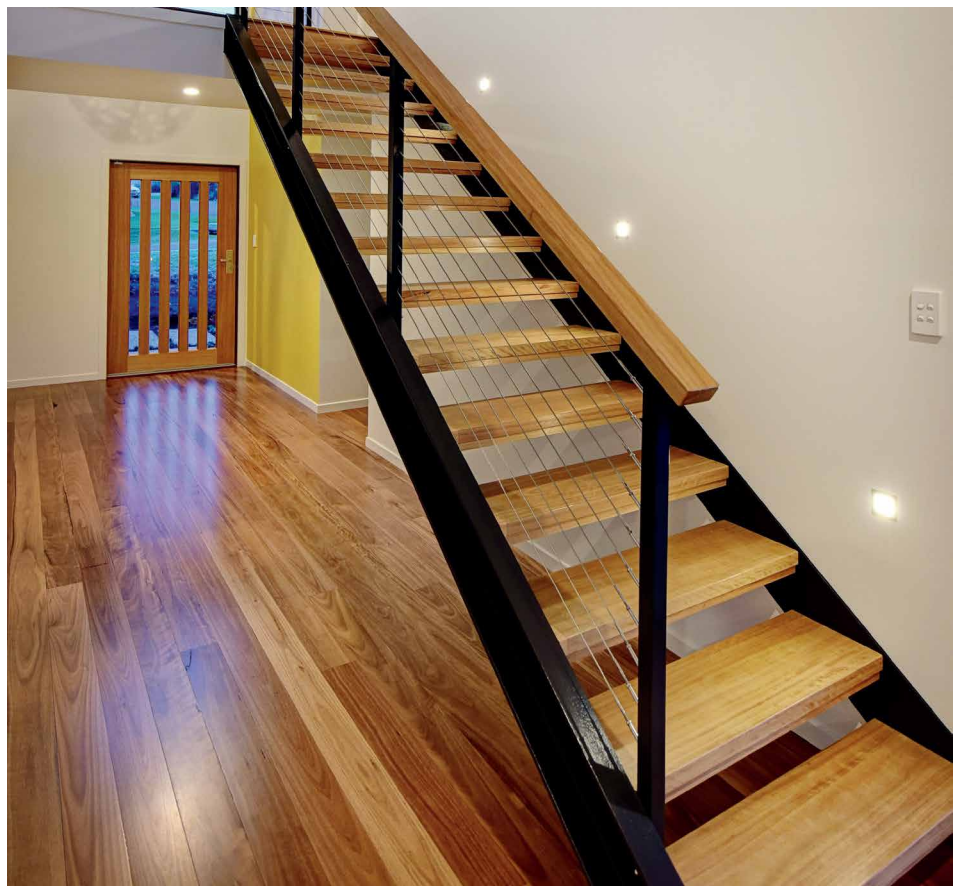

Above: Appropriate subfloor conditions will help timber floors remain level and aesthetically pleasing for many years with just an easy regular maintenance schedule keeping the shine on.

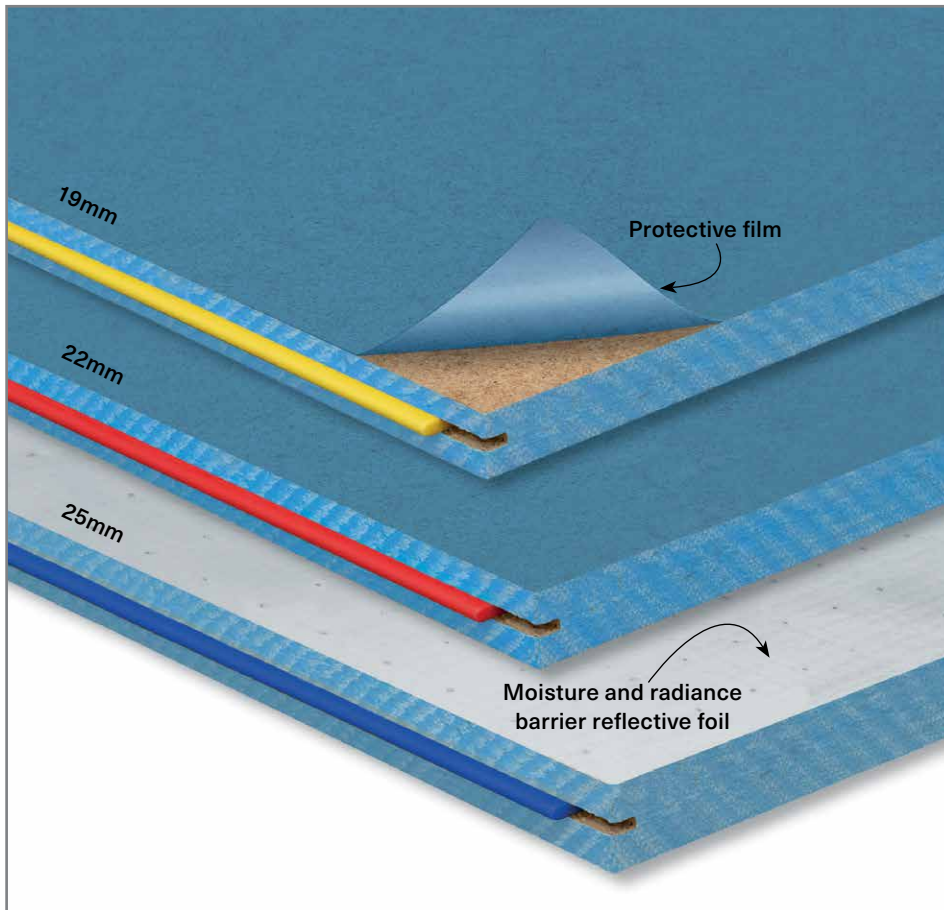

“We’re proud to offer the best in hardwood flooring products to our customers,” McCarthy says. “I know that, as a sales manager, I’m meant to be all about the volumes, but if we can provide a floor that remains beautiful and useful for the life of that house, that’s a real success story to us.”

THE BEST START

Keeping flooring at its best for decades has also inspired the team at Australian Panels. “We acquired the STRUCTAflor brand some years ago,” says Greg Muir. “That’s the famous YELLOWtongue board, plus several other products in the range. One of those was R-Flor.”

Originally developed as a way to add a layer of insulation to STRUCTAflor by laminating aluminium foil to the bottom of the board, R-Flor caught the attention of the team at Australian Panels, including Muir, who cut his teeth with the company running its Oberon mill.

“We realised two things,” Muir says. “The first was that people didn’t know much about the product, and the second was that there were a lot more features and a lot more >>

people in their forever homes, it’s durable, long-lasting, and easy to care for. But for a first homeowner, it might be a stretch.

“So we have our 13mm overlay flooring, which is a great choice for those who are looking for a more affordable option. It is still made from high quality hardwoods, but is thinner than the solid 19mm boards. That makes it a good product for renovations or for those who are on a budget or have height restrictions.”

CHH also has a comprehensive parquetry range, which gets the most out of its hardwood resource by making sure that smaller pieces can be used. McCarthy is a fan: “I think it’s a beautiful and elegant option for those who are looking for a unique flooring solution,” he says. “Our range comes in a variety of Australian species including blackbutt, blue gum, brush box, ironbark, spotted gum and tallowwood, and we supply block, mosaic and bespoke parquetry.”

Block parquetry is made from larger blocks of hardwood that are pre-arranged in a variety of patterns and can be laid in those blocks, with additional flooring patterns obtainable from the way the blocks are laid together. Mosaic finger parquetry is made of thin fingers of hardwood stuck down on sheets and laid mostly in a square on square mosaic formation, and bespoke is the high-end traditional type made up of repeating patterns constructed out of timber pieces of contrasting shapes and colours, usually all laid individually.

Above: R-Flor is based on a STRUCTAflor panel with protective film on top and reflective, perforated aluminium foil laminated on below.



STRUCTAflor stacks at Australian Panels – familiar YELLOWtongue at right.

“Overlay flooring is a good product for renovations or for those who are on a budget or have height restrictions, as it’s only 13mm thick.”

Radiant Barrier Structural Flooring

The ULTIMATE Sub-floor Solution

Bushfire Attack Level (BAL)

- If sub-floor is enclosed then R-flor can be used for the highest BAL rating of BAL – FZ
- If sub-floor is unenclosed then R-flor can be used up to a BAL 29

Increased R Value (Insulation)

R-flor provides a significant insulation R-value increase compared to normal STRUCTAflor YELLOWtongue flooring.

Reduced Moisture Uptake

80% less moisture uptake through the bottom surface compared to other common wood sub-floor products.

Termite Resistant H2

R-flor H2 is deemed to be a termite resistant building material under the Building Code of Australia and AS 3660.1.

Load Carrying Capability

R-flor comes in three thicknesses based upon what load factor is required:

- 19mm YELLOWtongue, 3600mm x 800mm
- 22mm REDtongue, 3600mm x 800mm
- 25mm BLUEtongue, 3600mm x 800mm

FREE SAMPLE

Order your free STRUCTAflor R-flor sample today by scanning the QR code below or by visiting www.australianpanels.com.au/ranges/structaflor-r-flor/

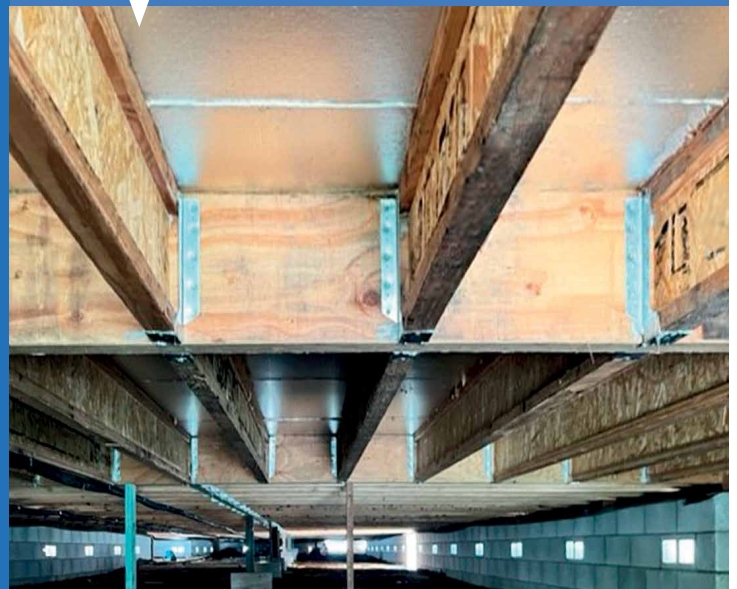
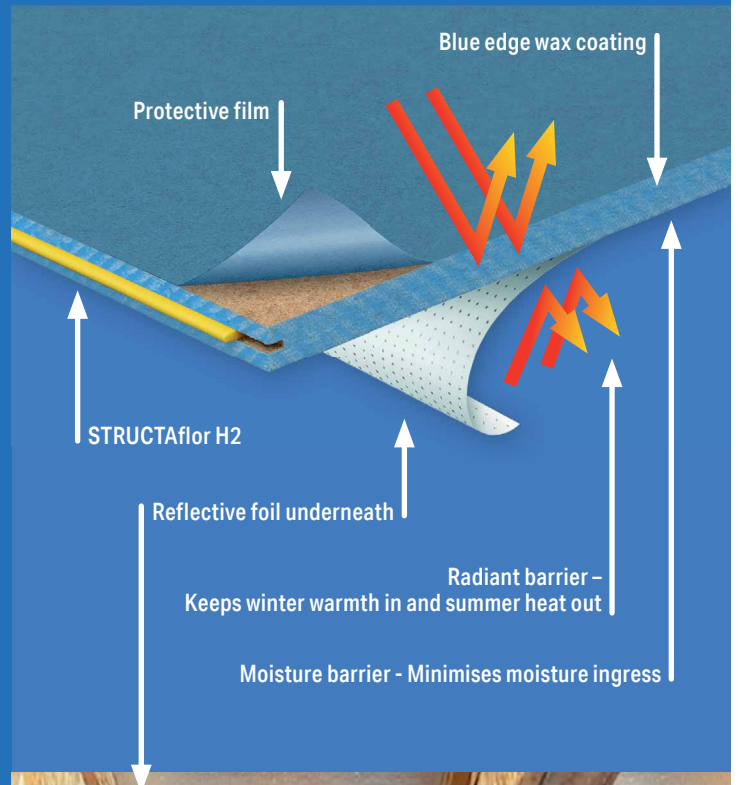

50 YEARS CELEBRATING
STRUCTAflor
YELLOWtongue

Australian
PANELS
www.australianpanels.com.au

potential benefits to the product than just insulation. And so I set about investigating and researching what else could this product actually do."

Fast-forward a few years Muir and his team have launched a revised R-Flor that can do a lot. "The first thing we changed was improving the plastic film on top," Muir says. "This reduces moisture uptake during construction, which keeps the board nice, strong and stiff. We've given it a seven-month exposure warranty, as opposed to the normal YELLOWtongue, which has five months."

"Once you reduce the moisture that can get in, you also significantly reduce the ability of mould to grow during construction, so the floor is in better condition and the house is healthier right from the start."

In trialling the original R-Flor, Muir and his team confirmed its known insulation qualities. "The aluminium foil increases the system R-value," says Muir. "When it's hot outside and that heat is coming up from the ground under the house, the foil reflects that heat back to the ground. In exactly the same way, when you're heating the inside of the house in winter, the foil keeps a lot of that heat inside your home, rather than letting it escape into the subfloor."

They realised that exactly the same physics that worked for insulation could deliver a higher BAL rating on the product, and testing proved that hunch correct. R-Flor now has a BAL 29 rating with an unenclosed subfloor and a BAL FZ rating when used with an enclosed subfloor (see the test samples on page 36 for the difference in charring with the same heat source/time between R-Flor and STRUCTAflor).

Muir says, "In a bushfire, if you've got sparks coming in under the home and therefore a lot of heat under the home, the aluminium foil restricts the ability of the heat and sparks to get into the timber and ignite it."

But the biggest discovery was that the foil also helped reduce moisture entering the board. "There's a really large reduction in the amount of humidity and moisture vapour that can travel up into the boards," says Muir.

"That vapour coming into the board over the life of the floor can cause a few things to happen. First is the growth of mould. The second is that moisture can soften the board itself and reduce its stiffness and the third is that the moisture can affect the floor covering that's laid on top of the R-Flor. Whether that's solid timber, engineered flooring, bamboo or laminate flooring, all

those timber flooring products are heavily affected by moisture, which can cause them to expand and cup or buckle.

"Just as the plastic keeps the boards dry from above during construction, the aluminium reduces that moisture coming up into the floor over the life of the house, and protects those floor coverings."

The result of all this investigation has been Australian Panels relaunching R-Flor as a specialist option. "The market we've seen emerge for this is with people who are aware of these sorts of risks," Muir says. "So that's a lot of regional builders, owner-builders and high-end builders who are concerned about environmental conditions, as well as builders who've been bitten in the past by rectifications for problems caused by damp."

The panels themselves are termite treated and come in three thicknesses: 19, 22 and 25mm, so are suitable for a range of load-carrying requirements from residential to commercial. Made in Oberon, NSW, they contain a high percentage of recycled material from the Australian Panels industrial recycling program, as well as Responsible Wood-certified trees from the company's forest resource. They install easily and, once the house is watertight, the plastic film on

BE *spoilt* FOR CHOICE



'Your one stop FLOORING SHOP'

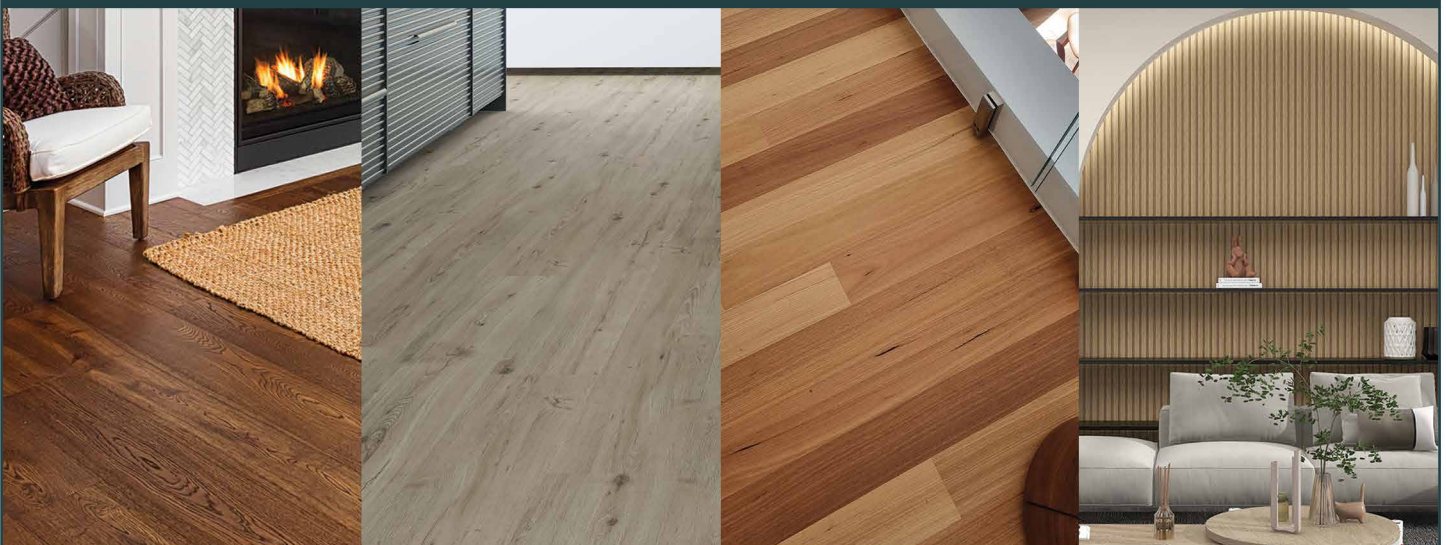

For more information go to our website: www.abbeytimber.com.au
Or call our office and speak to our team: 02 9774 2944



top can be removed to adhere flooring directly. The production team are also local, so any issues and consumer questions can be dealt with swiftly.

“The installation is straightforward,” says Muir. “I’ve written the installation guide for best practice, because if you’re going to pay the money for the best board, you should actually install it the best way.

“So for the R-Flor, you must screw it, to minimise movement and noise. You must use polyurethane glue and installers should smear a little of that adhesive along cut edges to mirror the extra protection given by the waxed edges on the uncut board. We’ve got videos to support the guide, so it’s very easy to follow.”

REAL-WORLD APPLICATIONS

It would seem to naturally follow that a board that can protect a homeowner’s flooring as well as improve the housing envelope has become a standard part of Australian builders’ repertoire.

“Not yet,” Muir says. “We find builders are still only looking to minimise upfront costs, and this board is more expensive. But in my job I take calls from a lot of homeowners. They ring me and say, ‘Hey, Greg, I just want

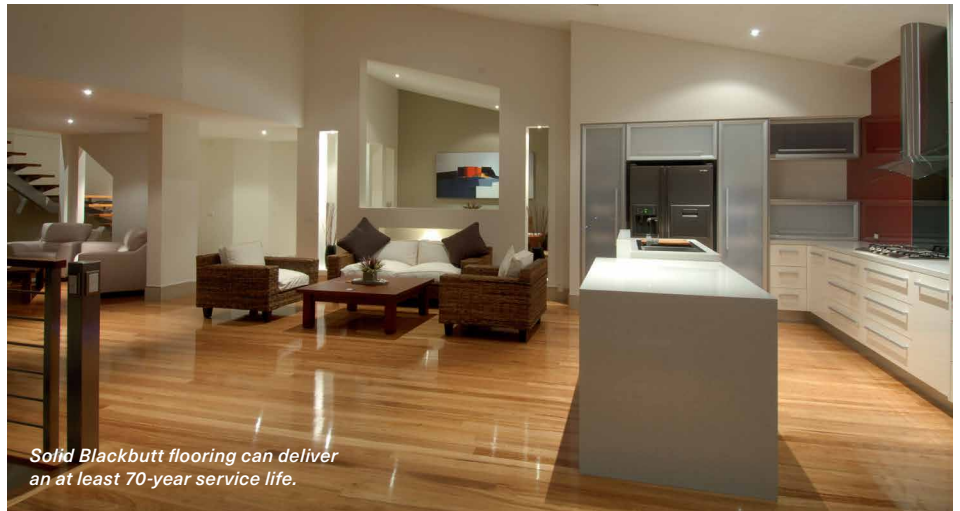

Solid Blackbutt flooring can deliver an at least 70-year service life.

to understand how do I lay YELLOWtongue?’ And I ask them, ‘Where’s your home? Is it near the water? What flooring are you putting on it?’ And a lot of the time, I’ll tell them the product they actually want is R-Flor.

“And I’m upfront; I tell them it’s double the price but these are the benefits. I reckon the conversion rate of people ringing me would be close to 100%. The homeowner wants the product because they can see the problems it solves and that it will save them many times the extra cost over the life of the home.”

Builders, on the other hand, have been less

inclined to inquire about new products, preferring to stick with what they know, says Muir, adding: “To be fair, we do get calls from good builders, particularly with tricky sites, and from ones who have had problems in the past with time frames and are looking for options that will last longer in the open.

“But most of the people we talk to are homeowners. We’ve also had a lot of ATFA members talk to us about R-Flor, because they want the best base for their products, but they’re generally coming in after the home has been built and don’t have a lot >>

PHOTO: COURTESY COFFS HARBOUR HARDWOODS





Showroom of the Year 2023

HARDWOOD FLOORING

Suppliers of:

- Traditional Solid T&G Hardwood Flooring
- Solid Hardwood Overlay Flooring
- Stadium Sports Floors
- Block Parquetry
- Mosaic Finger Parquetry



www.coffshardwoods.com.au

Ph 02 66492006

Showroom Address 32 Lawson Crescent, Coffs Harbour NSW 2450
 Mill Address 161 Tallawudjah Creek Road, Glenreagh NSW 2450



Above: The builder of this Sunshine Coast house had seen the mould problems in the previous home on the site and so sought out a flooring board that would help to minimise moisture transfer.

of influence on what boards are laid at that point. Right now, we're relying on the homeowner saying to the builder, 'I want that product in my home.'

Bear in mind that 'double the cost' in this case equates to roughly \$2000 on a standard floor size and it's no surprise to see homeowners leading the change: the savings on the household energy bill alone will pay for it over the life of the floor.

One region where Muir has had a lot of interest is Queensland. "We've seen a lot of flooding in Brisbane in recent years and, while homes are built high for that reason, when the bottom garage level floods, the high humidity and moisture hangs around for weeks or months and comes up through the subfloor, damaging both the boards and the floor coverings," he says.

"A lot of rebuilds have used R-Flor: while it won't handle being submerged for weeks, it will protect your home from that high

moisture build-up under the floor while you deal with draining and drying out your bottom sub floor area."

In the nearby Sunshine Coast, Blac Blanc Building has used R-Flor on a new multi-million dollar build (images at top of this page). "In this case, the builder went out to the original home before they pulled it down," says Muir. "He saw a lot of mould, a lot of rising damp and realised it was virtually impossible to get adequate drainage under the home because the surface water is so high there. So he went looking for the best products he could use to reduce the risk of that moisture coming into the new home."

The issues were substantial: with no way of resolving the drainage issues on the site, the house had subfloor readings of 85.5% humidity and 28.7°C, even with exemplary cross ventilation. Moisture readings on the flooring I-joist were 20% and timber on the ground was at 50% moisture. However the above-floor moisture reading over the R-Flor was just 12% and there was a noticeable drop in temperature inside.

The builder, Dan, was so pleased with the product that he's produced a video on the project with Australian Panels.

"One important thing to note is that the foil is perforated, so there is vapour movement through the board," Muir says.

This means that while humidity and heat from outside the house are greatly slowed

down in their movement inside, humidity from *inside* the house can still escape.

"This ties in neatly with the new NCC requirements coming out towards the end of the year that a whole-of-house approach in terms of insulation, air flow and those types of things," says Muir.

One unintended consequence of recent NCC changes could be a rise in mould in the subfloor of some builds. "That's because the NCC requirements are now aimed at cutting down draughts," says Muir. "That gives you a positive for energy costs, but it gives you a negative for dew, moisture and internal condensation. In the past, there was a lot more underfloor ventilation, now that's being reduced, because the higher the air movement through a house, the higher your energy costs. But the downside is, many new homes hold onto moisture."

The foil on the bottom of the R-Flor boards is perforated, so it allows for moisture vapour to move slowly through the boards, lowering the indoor humidity without holding excess moisture against the floor coverings. "It still delivers an improvement in insulation, but it's not creating a sealed environment where the moisture can't escape," Muir says.

"So the moisture vapour we produce in everyday life isn't trapped in the floors, where it can form mould and create health problems and rising damp."

The problem has been exacerbated by building delays in recent years. "Even in Passive Homes, where air movement is controlled through a filtration system, we've seen water get into the boards during delays in construction," says Muir. "I've had owners calling me and saying they have mould. Many of the people attracted to that style of house want it because they have serious allergies, so they are exactly the people who can't be around mould."

While moving into the Passive Home sector is a future plan, Muir's team are focused on spreading the word about R-Flor.

"We've just launched it through Bunnings, and while it's not on the floor in their stores it's on the website. Which is big for us, because that's where a lot of homeowners start to look when they're thinking about materials and performance," Muir says.

"We think they'll see the obvious: if you're going to be laying a beautiful timber floor, you should start with the panels that will keep it looking great for decades."

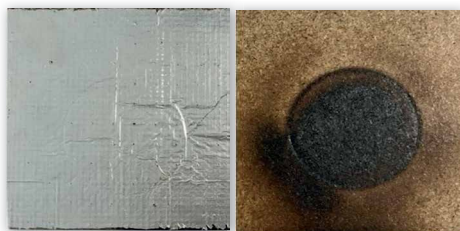

Above: The same flame test on R-Flor, left and Structaflor, showing R-Flor's higher resistance.

**For more information, visit <https://coffshardwoods.com.au> or www.australianpanels.com.
au or scan the QR code to see the Sunshine Coast house video.**



PHOTOS: COURTESY AUSTRALIAN PANELS



Above: Simpson Strong-Tie's SDWC truss screw replaces framing anchors for rafter and truss to top plate connections.

Trusted connections

The right choice in timber connectors can elevate a design aesthetically, make it easier to achieve and even make the building site safer. **By Donyale Harrison**

Beautiful timber structures are made by their connection choices. When the connectors used are designed to work with the architecture of the structure and show off the materials to their best advantage, everybody wins. The homeowner has a result they love, the builder has a show piece to add to their portfolio and the designer looks like a well-informed expert.

The good news is how easy this result is to obtain. Leaving aside nailplate specialists for the moment, Australia has multiple high-quality connector specialists who are all hugely invested in educating the marketplace and sharing their expertise.

We spoke with Grant Brown, national sales manager at VUETRADE, and Matt Smith, national field engineer at Simpson Strong-Tie, about some of their companies' newest and best options, plus how connector specialists can grow your business.

CELEBRATING TIMBER

"If you're designing timber entryways for the front of a house, or a pergola or other high-end renovation, you should be looking at our T-blade," says Grant Brown.

"Historically, those sorts of timber posts have used stirrups or bolt-downs where you had the ugly metal sides protruding and heavy bolts running through them. Our T-blade system is almost entirely concealed: you notch the timber and the blade fits into the middle of that member. There's a minimal foot and a neat stainless steel cap that slides over it, then everything is secured with VUEBOLTS, which have attractive rounded heads."

The system isn't just a significant improvement when it comes to the look of a project (see the images on page 40), it's also highly practical.

"It's engineered 316 stainless steel, so you have a long-lasting, strong product with a

very tidy finish," Brown says. "The cap conceals the ugly bolts that are attaching the blade to the structure and the VUEBOLTS are a male-female bolt system with a T-50 head that tightens up inside the timber, leaving only the small rounded heads visible. You don't get those protruding bolts and ends that kids can gouge their ankle on when they're running around in the pergola or on the deck."

Available in sizes from 90-250mm, VUEBOLTS are particularly appropriate for premium, large-section posts. In areas with strong termite activity the T-blade bolt hole locations are designed so that posts can be lifted up to 5cm from ground level to provide a physical barrier to access and an appealing 'floating' appearance.

"This system is gaining a lot of momentum at the moment as renos take up a bigger part of the market," says Brown. "We're seeing it used on pergolas and the entry points to >>



Above: Using the right joist hangers, like these from VUETRADE, will add years to your deck's service life.

multi-million dollar homes, where you've got those beautiful bits of expressed timber and it's such a waste to have one of those awful locking bolt downs when they could have a T-blade system with VUEBOLTS."

VUETRADE's wider range includes a full set of stainless steel connectors, which makes sense given how many of us live close to the coast in Australia. "A lot of our work has been on educating people about this," Brown says. "We've really started targeting builders, because that's where it's falling down; they're often quite blasé about the requirements and don't realise the importance of the standards."

"The choice between stainless steel and galvanised product sounds as though it's just another option, but it's super serious. I was in Yeppoon last year, talking with a customer and the inspector for the region dropped in. We went for a coffee and got talking and he told me of a wall on a fish and chip shop on the Esplanade that fell down over a walkway. It was only five years old, but they used galvanised masonry joiners. And of course, they all dissolved and, on a gusty day, it fell over. They were lucky that this was just an expensive repair, but there are serious implications of cutting corners."



Above: Galvanised products aren't suitable for coastal sites like this picnic shelter as they rust and let rot into surrounding timbers. VUETRADE has often been called in to replace product like this with stainless steel.

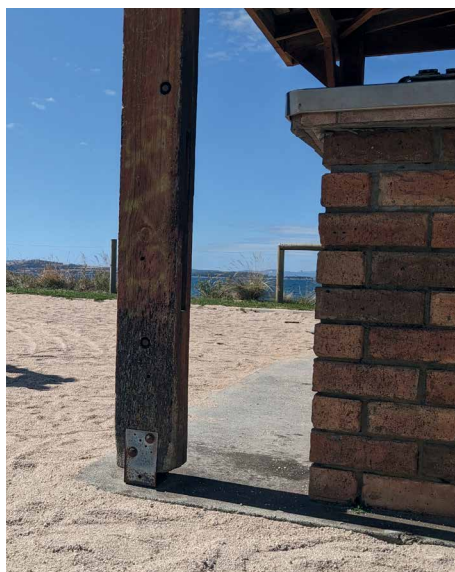

"We've really started targeting builders, because they're often quite blasé about the requirements and don't realise the importance of the standards."

Brown knows that in some cases, the wrong choice is made in good faith, so has worked to make it easy for retailers stocking VUETRADE product to know which option to use. "Because galvanised connectors will do a great job in the right location, and they are cheaper," he says.

"We've recently put in some signage at the 316 Fastening Shop in NSW. They had a big wall available and we've used that to put in a map that shows the areas where you need stainless steel, so now all their customers need to do is check the location of their job against the map.

"And for areas where you do need the stainless steel, homeowners can understand that if the builder takes the time to talk with them. They want a beautiful addition to their home, particularly if it's their forever home. If you're using gal on a deck around a salt-water pool, in five years, it's going to fail and may injure someone. Whereas if the builder has said 'OK, so this isn't the cheapest, but the reason we need this is because of where the connector is located', then homeowners are very happy with that explanation."

PITCHING EASE

"It's a handy little connector!" says Matt Smith, talking enthusiastically about the new Simpson Strong-Tie VGT (Variable-pitch Girder Tie). Designed to deliver a reliable tie down without creating the additional problem of brackets interfering with battens and adding to the depth of a roof profile, the VGT has proved to be even more useful than Smith was expecting.

"People have been asking if we have a solution for this need, because most other big tiedowns have to go over the top of the roof truss and can interfere with your battens," Smith says. "But this fixes to the side of your truss, so it doesn't clash with any of your roof material or battens. Add to that, the same bracket works for multiple pitches. There's a U-shaped washer at the base of the bracket that can adjust from 0-35°. At the moment, a lot of other brackets, particularly >>>

PHOTOS: COURTESY VUETRADE

JOIST HANGERS

Innovative, Quality, Time-Saving Products



Saving you time during install



Australian Made



Unique VUESPIKE



Australian Standards

FEATURES & BENEFITS:

UNIQUE VUESPIKE

- Holds the hanger in position while you hammer.

Meets and Exceeds AS1720

- The Australian Standard of Design Methods for Timber Structures.

Australian Made

- VUETRADE Joist Hangers are all certified Australian made, right here in Victoria.

Manufactured and packed straight

- No flared brackets mean ease of use and time saved on site.

Size Range:

35 - 50 mm

Timber Width

90 - 220 mm

Hanger Height



Full range of Timber Connectors available:



Bracing & Tensioners



Building Brackets



Framing Connectors



Masonry Ties



Post Supports



Vents



Ant Caps

MORE INFORMATION:



vuetrade.com

AVAILABLE IN:



Galvanised and 316 Stainless Steel



Above: VUETRADE's T-blade system shows minimal steel, delivering a tidy, safe connector that highlights the real visual hero of the design: the timber.

“A big thing with that SDWC truss screw is that it can be installed by a worker on the ground using our Quik Stik. So you don't have to work at height.”

in Northern Australia, are welded to the right pitch, which can be really expensive. The VGT is one product for a range of pitches.”

These sorts of connections are often positioned in the corner of structures, where the sections of the roof trusses meet and room is limited. “That's another benefit of the VGT,” says Smith. “It alleviates those

problems of restricted space, and it can tie down more than roof trusses, it would work for a beam with high uplift as well. It should predominantly see a lot of use in North Queensland, Darwin and Western Australia, anywhere you get C2, C3 or N3 and N4 wind speeds and need that extra tie-down, such as close to the coast or near a hillside.”



Above: The new VGT from Simpson Strong-Tie solves a raft of design and installation issues in one product.

Smith and the Simpson Strong-Tie team have spent the better part of a year testing the VGT for compliance with local standards.

“It's a product I'm really excited about,” Smith says, “and the few builders and frame and truss guys I've mentioned to have all been ‘This is great, when can we have it?’ They've had to wait, because we go through a really detailed testing and assurance process to make sure everything's right for the Australian market. We test with a huge range of different grades and thicknesses of timber and at different pitches for the roofs as well, from flat to 35°, to make sure it's compliant to the Australian standards.”

Although the VGT passed through without difficulty, that comprehensive process has been valuable for tweaking other products.

“There have been cases where something will fail prematurely, so we know it's not right,” says Smith. “In some cases, the product isn't suitable for our needs, but in others that testing process will show how we can improve it to meet our standards by putting in an extra screw, making it a little bit bigger or adding a reinforcing rib.”

It's a process that has seen Simpson Strong-Tie at the forefront of introducing new types of connectors in recent years. Smith says, “We were the first ones to bring out truss screws and stud screws, and those are really useful products that have found wide acceptance. Most of our competitors also stock versions these days.”

Along with the products has come a focus on how they are used. “It's almost a motto at Simpson's: we want to build safer, stronger structures,” says Smith. “A big thing with that SDWC truss screw is that it can be installed by a worker on the ground using our Quik Stik. So you don't have to work at height, there's no need for a scaffold, the worker just walks from one location to the next and installs them all from below, which is much safer.”

PHOTOS: COURTESY VUETRADE (TOP); SIMPSON STRONG-TIE (BOTTOM)

MAKING THE RIGHT CHOICE

Both the VUETRADE and Simpson Strong-Tie teams have found themselves having to do a lot of work on educating the broader market about the right choices for particular environments and needs.

"I sympathise with the urge to just get the job done," says Brown, "because times are hard and they can feel as though they just need to concentrate on the next job – and by 'they', I mean both builders and merchants. But we see the difference that a real depth of product education makes.

"On the merchant side, look at Bowens. They spend a lot of money in training and educating their team, same with people like Narangba Timbers here in Brisbane. So they become a trusted destination for builders and landscapers and they hold onto their staff longer because they invest in them."

Builders have different priorities, Brown says. "What we see regularly is they go out to a job, have a quick look around, submit a quote and win. And only then they do go back to get the finer details and realise, 'Oh, jeez, we're a stone's throw from a waterway...'

"We know this happens because they're time-poor, but it means that they quote on the galvanised product, but need to be using the stainless steel, which is three times the price. And sometimes they convince themselves the gal will suffice, when it won't.

"So we're focusing on educating the builder, because they're the weakest link in the chain at the moment. And we're giving them the language to talk to their clients so they understand why their builder is wanting to use stainless, or why they're wanting to

use other products, like the T-blade, that will just do a better job with a better result."

Education has been key at Simpson Strong-Tie, too. The company's range of free downloadable publications includes one on mass timber construction as well as several on the company's various fastener and connector systems and there is a publication underway for high-wind zone construction that will feature the VGT bracket.

"But Simpson is probably best known for going face-to-face with a lot of different people," says Smith. "We do training days for our larger distributors like Mitre 10. We also have a team of people who go around to building sites and show them how to use our products. We let them know that if they have any problems, they can give us a call and we'll send someone out to them. That goes for builders, architects and engineers. So we're training and educating at all levels of the supply chain."

Like Brown, Smith has seen the results of their efforts: "When everybody's on board, and the engineers and the designers understand the product and specify it correctly, then the final build flies through certification. And we help that by going to certification conferences and doing presentations on our product ranges. It all flows smoothly if everyone's on the same page."

Which is not to say that some people aren't reading an entirely different book.

"I had a call from a builder the other day," Smith says, "and he said, 'These screws of yours are snapping!' So we went out on site and had a look and they weren't our screws. They'd gone and bought a cheaper version.



Above: Installing Simpson truss screws using a Quik Stik, eliminating the need to work at height.

We had to politely say, 'Well, that's what happens when you don't use the proper quality screws that have been tested.'

"I don't think they realise the implications of those sorts of substitutions, that it shifts a lot of the risk onto them. Maybe some >>

PHOTO: COURTESY SIMPSON STRONG-TIE

The Complete **Strong-Drive**® Framing Solution

SIMPSON
Strong-Tie



SDWS Structural Screw

SDWS

Top and bottom plate to stud
Eliminates the need to use strapping



SDPW Deflector Screw

SDPW

Non load-bearing walls to trusses & joists
Eliminates the use of hitch plates



SDWC Truss Screw

SDWC

Rafter and truss to top plate
Eliminates the use of framing anchors



Quik Stik™

Quik Stik

Rafter and truss fastening system
Ergonomic and safe installation of SDWC



View the full range at
strongtie.com

Simpson Strong-Tie® Australia Pty Ltd
Call **1300 STRONGTIE** (1300 787 664)
www.strongtie.com.au



Above: Simpson Strong-Tie's Quik Stik system is easy to use in confined positions.

hope for the best and they'll jump the failure hurdle if it happens. We keep telling people that the risks aren't worth it – so does the whole industry!"

Both have also seen more benign problems, which often have easier solutions thanks to VUETRADE and Simpsons both having in-house engineers available.

"We had one of our builder's apprentices botch some joist hangers on a job," says Brown. "They reached out and sent us some photos because it was going to take a huge effort to get them out and replace them. Our head engineer, Danzel Teh, spoke to them at length and actually came up with an alternative to manage the load with some modifications. It was all signed off and everyone was happy."

But Brown and his team have also seen sub-standard product in the marketplace. "A lot of the time it's coming in from other markets, where it might be fine for those conditions, but it hasn't been engineered to meet Australian standards," he says.

"It can be frustrating for local suppliers who are conscientious about meeting standards, whether that's for tested imports or local manufacture. For example, we make our sheet material product ranges in Ballarat. And for all those sheet material products we use T300 stainless and Z275 galvanised, which are what's required. Ours are manufactured from 1mm sheets, while people are importing 0.8mm. It's a minuscule price difference, you're talking a handful of dollars, but one type of product is to

"It makes sense for hardware stores to have a good relationship with a reliable connector partner. It's an easy way for them to increase their revenue."

standard, audited and often creating local jobs and the other is all risk."

Smith has real concerns that the wider industry will be left to manage the fallout if there are notable failures. "So far we've been lucky – there are some good certifiers out there picking up when the wrong product has been used, but that takes a lot of training," he says.

"I worry there will be a failure that injures people, or worse. Because that's what draws the attention of both negative media coverage and the government, who deal with it by putting pressure on the industry. We've seen the pushback when events like that occur and it damages the whole sector. There was that roof collapse at the Riverside Golf Club years ago and it resulted in a push by some people to ban roof trusses altogether. Nobody wants a repeat of that."

FORGING NEW CONNECTIONS

Delivering innovation and education requires a strong connection with the marketplace, and both Brown and Smith say their teams prioritise communication with their whole customer base.

"We work closely with all of our partners to make sure we're keeping up to date with building trends," says Brown.

"Some of those trends might only last a few years, but we can often adapt a product we have already tested to make sure that it's fit for purpose for what our partners' customers are building.

"That may be as basic as a change to a simple joist hanger, but what that means is that the retailers who are selling VUETRADE products have what their customers want, and that's very empowering for them."

VUETRADE also runs a Platinum Partners program for their biggest customers. "These are customers who are often selling 100% our products and it brings them a range of benefits," says Brown. "There are simple ones like no freight charges and no minimum orders. Then we have regular meetings where we assess their business and find ways we can help to build their business and build the timber connectors category.

"That could be the way we present in store and at the point of sale, or it could be our marketing team doing specialised and tailored social media items, that our partners can post. We streamline a lot of things that

can be pain points for a lot of them, or which they don't have time to tackle."

There's a similar hands-on approach for the team at Simpson Strong-Tie. "We make ourselves available," Smith says. "Whether that's at conferences, over the phone or on site, we talk to our customers and their customers, both so that they feel more secure in their knowledge of our products and so we can stay abreast of what they're doing and what they might need."

Backed up by the international parent company, Simpson has a comprehensive body of pre-tested product available that can adapt to new building trends, as well as the ability to modify existing product quickly.

Smith points to a new Meyer Timber product, meyBATTEN. "This is a new LVL roof batten product," says Smith. "We've recently released a new, smaller version of the SDWS screw, the SDWS16, that works perfectly with it. It's one of those cases where when a customer asked a question, we already had the answer in our range."

And, for one-off designs, VUETRADE also has a custom work option. "We do a large number of custom products each year," says Brown. "With our testing facility and our engineers based here in Australia, we're able to deliver solutions – along with diagrams and testing data – for one-off builds and we regularly provide our customers with quotes on that sort of work."

He's in full agreement about the importance of talking with customers: "I get around all the states and meet most of them," Brown says. "It's the simplest way to hear what's actually needed out there. And our Australian-based product development and manufacturing facilities can turn that market feedback into new products."

For both Simpson Strong-Tie and VUETRADE, time spent on research has shown results, with each having committed retail customers who derive a lot of business from stocking the brands.

"It makes sense for hardware stores to have a good relationship with a reliable connector partner," says Brown. "Because we deliver so much added value and education, it's an easy way for them to increase their revenue and make them a destination rather than just another hardware store." **T**
For more, visit <https://strongtie.com.au> and <https://vuetrade.com>

RANDEK™

Innovative solutions for prefabricated house production

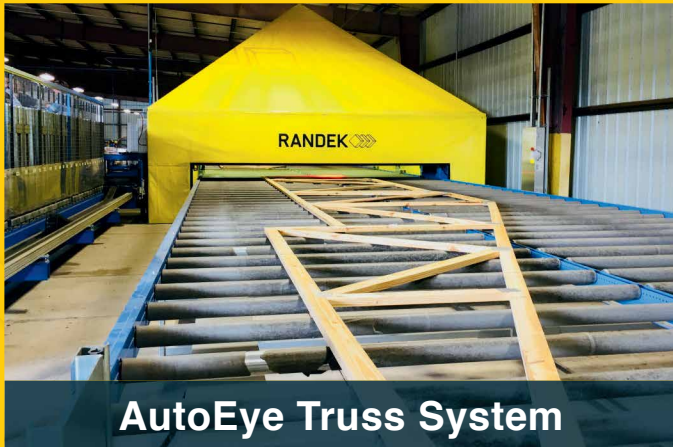

AutoEye Truss System



AutoFloor System

BUILDING THE FUTURE



AutoWall Framing System



ZeroLabor Wall Panel System

Exclusively represented by



For further information please call 03 9850 6666
or email sales@blissandreels.com.au



Figure 1: LVL used as the bottom chord of a truncated girder truss.

LVL in trusses

With a few watchpoints in mind, LVL can be a valuable part of your timber truss design arsenal.

By Afzal Laphir, Principal Engineer, Meyer Timber Pty Ltd

Laminated veneer lumber, more commonly known as LVL, needs no introduction, having made its mark over many years of use in Australia as a high-strength, dimensionally stable, reliable and low-cost engineered alternative to sawn timber.

Recently, there has been considerable discussion regarding LVL compliance, especially with the entry of new suppliers into the market. As a result, a number of publications and articles pertaining to this subject have emerged, including an EWPA/FTMA technical alert, the Meyer Timber factsheet on LVL compliance and recent feature articles in this magazine. That being the case, this article will steer away from compliance and focus on the things to look out for when using LVL in trusses – as well as discuss the properties that matter.

STRENGTH AND STIFFNESS PROPERTIES

The characteristic properties of LVLs are not listed in Australian standards (unlike MGP, F-grades, and glulam). Each LVL supplier is responsible for providing the specific

properties of their product, determined in accordance with AS/NZS 4357.0. Its non-standard nature means the property values of LVL can vary between different suppliers, even if they have a similar branding (e.g. LVL14, E14, etc).

When LVL is intended for a specific use, only the properties relevant to that particular application need to be determined and published. For example, if LVL is to be used as beams and lintels, the minimum properties required are the Modulus of Elasticity (E value), bending, shear and bearing, along with the joint strength of nails, screws and bolts.

However, if the LVL is intended for use in trusses, three additional properties must be determined, namely compression, tension and the joint strength of nailplates.

NAILPLATE PROPERTY

Of these additional properties, the nailplate property or the tooth-holding capacity requires special emphasis as it is influenced by a number of factors, including the veneer characteristics (eg: species, thickness, grain

direction etc) of the LVL and its production. This results in very different values between suppliers whether the nailplate is pressed into the face or edge of the LVL.

It should be noted that the tooth-holding capacity is dependent on how the teeth are orientated to the grain of timber and the direction of force, which is different to conventional joints using screws or nails. The nailplate property is also dictated by the method of truss fabrication, depending on whether a platen or roller press is used.

Given the many influential factors as discussed above, rigorous testing of the nailplates is essential. This testing process is carried out by each nailplate company using their proprietary nailplates on a given LVL, to determine the specific tooth-holding capacity for the different conditions. As there are multiple variations to the test regime, it may take several months to complete.

The results of these tests then need to be incorporated into the proprietary software of the respective nailplate companies, which can also take a few months, depending on the release cycles of the software.

SUBSTITUTION: BEAM Vs TRUSS

For beams or lintels, the primary design focus is on their ability to resist bending. In such applications, the design is limited typically by deflection or stiffness. The 'E' value (Modulus of Elasticity) becomes a crucial parameter as it influences the beam's stiffness. As a result, in beams and lintels, substitution of LVLs from one supplier to another can normally be achieved following a simple design check, provided their 'E' values are similar.

On the other hand, in truss chords, the design is subjected to a combination of axial forces (tension or compression) along with some bending and shear forces. The interaction between bending and axial loads is usually critical in such cases. Additionally, the variation in nailplate properties adds another layer of complexity to the design. This means in trusses, substitution of LVLs from one supplier to another is not straightforward and must not be done for any member without further assessment.

LVLs of a similar E value may have more pronounced variations in their bending, compression, or tension strength properties, and such differences can be exacerbated under combined actions. So, if replacing one LVL with another in this type of application (see Figure 1, main image above), a full truss re-design is required.

LVL IN FLOOR TRUSSES

LVL can also be used in floor trusses, as top and bottom chords, provided the necessary

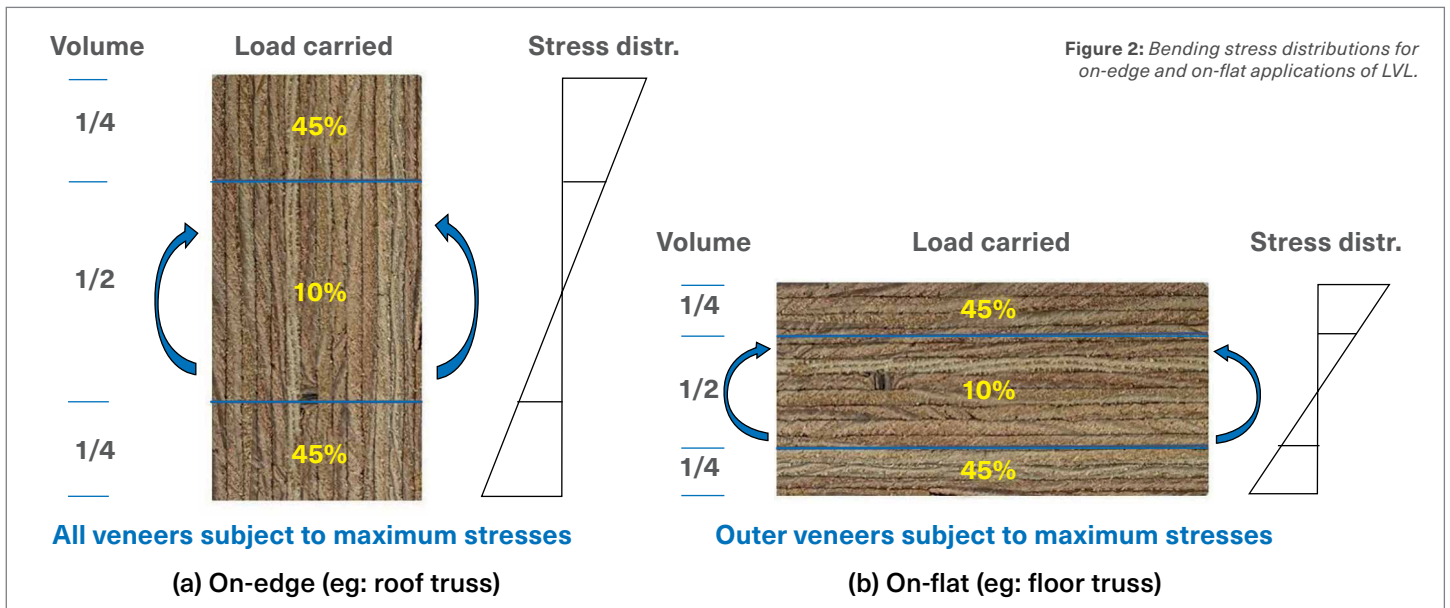

When designing LVL in trusses, only the designed LVL can be used.

assessments have been made and are available for use in the proprietary software offered by the nailplate company. Firstly, the characteristic 'on-flat' properties must be established which are often lower for bending and shear than the on-edge values. As illustrated in Fig 2 (top of page), the peak bending forces of an on-flat member are concentrated on the outer veneers unlike in a standard roof truss 'on-edge' application where the forces are evenly distributed across all veneers. Secondly, the nailplate properties need to be determined for teeth embedded into the edge of LVL.

BENEFITS OF LVL

LVL offers numerous advantages over sawn timber, making it an ideal choice for truss applications due to its dimensional stability, high strength, wide sections, and long lengths. In truss design, the combined strength actions of bending and compression (or tension) take precedence over the E value. LVL's superior strength properties, as compared to sawn timber (refer Table 1, above right), allow

TRUSS MEMBER	LVL E15	SAWN TIMBER SUBSTITUTION		
		MGP12	MGP15	F17
TOP CHORD Bending & Compression	90 x 35	140 x 35	120 x 35	120 x 35
BOTTOM CHORD Bending & Tension	140 x 35	240 x 35	190 x 35	140 x 35
Strength Properties f'b, f'c, f't (MPa)	50*, 45*, 35*	28, 24, 12	39, 30, 18	42, 34, 25

* Assumed nominal values for LVL E15 (90 wide section). The Characteristic strength properties refer to Bending (f'b), Compression (f'c) and Tension (f't)

Table 1: Top and bottom chord specification of a 6m girder truss carrying 6m standard trusses (tile roof).

for more efficient design of truss members.

An example of a typical 6m-span girder truss demonstrates how LVL E15 can lead to reduced section sizes when compared to sawn timber, resulting in cost savings. Importantly, LVL E15 retains a 90mm top chord, ensuring the plumb depth (heel height) remains consistent with the rest of the roof. The section sizes in Table 1 are based on the girder truss supporting 6m standard trusses and a concrete tile roof in the N2 wind region.

Similar to the E value, the influence of the nailplate property of an LVL is also overshadowed by the strength properties. Even if the tooth-holding capacity of nailplates varies between LVLs, the design differences and associated cost variations in a girder truss remain relatively small. Heel plates and splices in such trusses are often governed by steel strength, which remains independent of the LVL being used. Therefore, the superior strength properties of LVL are the primary factors driving its

advantageous use in trusses.

The benefits of LVL have made it a commonly available building material in Australia and we need to relay the message of using it properly. Builders become complacent and with limited knowledge have started to adopt the "same, same" attitude. Whilst substitution in beam applications can be done with a simple design check, if a Frame & Truss plant is designing LVL in trusses then only the designed LVL can be used. Any changes must only be done after a full re-design. The attitude adopted here should be "not same, not same, and different". **T**

For more information, visit <https://ftmanews.com/wp-content/uploads/FTMA-Tech-Alert-LVL-Compliance.pdf> and https://meyertimber.com.au/wp-content/uploads/MT_Factsheet_LVLCompliance.pdf



For more information on this topic, contact Afzal Lahir via email at AfzalL@meyertimber.com.au



DIAGRAMS & TABLE: COURTESY MEYER TIMBER

NCC 2022 again

An easy-to-miss change in the new standards could have significant impacts on two-storey designs.
By Craig Kay, national product engineer, Tilling

According to dictionary.com, ‘the devil is in the details’ is an idiomatic phrase that means “even the grandest project depends on the success of the smallest components.” These are the components that, if not closely paid attention to, could possibly ruin all your efforts. As in, the devil in the details may ruin your feasibility.

In his Timber Noggins article in the March/April 2023 edition of *TTN*, George Dolezal alerted industry to some new construction requirements that will become mandatory when NCC 2022 becomes operative, and how these may have implications to the way timber structures are designed.

Importantly, NCC 2022 is being implemented in two stages, with the majority of changes taking effect in all states and territories from 1 May this year (except WA where NCC 2022 will commence from 1 May 2025). A further transition period applies for the liveable housing, energy efficiency and condensation management changes, which are progressively commencing in various states and territories from 1 October 2023. Victoria has recently announced that these provisions will now become effective in May 2024, to allow all practitioners who need it more time to get up to speed with these changes while they continue to use the relevant provisions of NCC 2019 in the interim.

The new energy efficiency and

condensation mitigation requirements, when adopted, will be at the forefront of the push to make housing more sustainable. They are designed to make homes cheaper to run, more comfortable to live in and more resilient to extreme weather.

Now that industry is operating under NCC 2022, the practical implications of the new provisions are becoming obvious. Project builders of multi-storey dwellings who offer customers a range of standard model designs have realised that they will need a major rethink about the design of sanitary plumbing in the upper level.

NCC 2022 introduces an obvious clause (discussed below), but another addition may have missed people’s attention, hence the reference to ‘the devil is in the details’.

10.2.12 CONSTRUCTION OF WET AREA FLOORS — FALLS

Where a floor waste is installed—

- (a) the minimum continuous fall of a floor plane to the waste must be 1:80; and
- (b) the maximum continuous fall of a floor plane to the waste must be 1:50.

This applies regardless of whether the floor waste is a ‘required waste’ under the wet area waterproofing standards or is just included to simplify the plumbing design.

To anyone reading the NCC, this clause is clear, and is identified as being [new for 2022]. What is not so clear, is that NCC 2022

also introduced an updated version of AS/NZS 3500.2:2021 Plumbing and drainage Part 2 - Sanitary plumbing and drainage standard.

The 2021 edition of AS/NZS 3500.2 introduces a new clause 4.9.1.2 “Where a junction is used to make a connection of a DN100 branch drain to another DN100 drain, the entry level of the branch drain shall be elevated at an incline of not less than 15° above the horizontal.”

The positioning of the junction at a minimum of 15° above horizontal is designed to remove the probability of the partial backwash of a discharge into the branch causing stranding that can lead to blockages in the drain.

The image below is reproduction of part of Figure 4.9.1 giving some typical arrangements for a graded branch entering another drain.

The diagram demonstrates the 15° fall from the branch drain into the outlet, and in the case of drains of unequal sizes, there needs to be a minimum of 10mm fall from the invert of the branch drain to the soffit of outlet drain. If we use a DN100 feed drain and a DN125 outlet drain as an example of an unequal junction branch drain then for new builds, according to the above reproduced figure from the standard, there now needs to be a fall at the connection of approximately 135mm.

One can understand why builders of two-

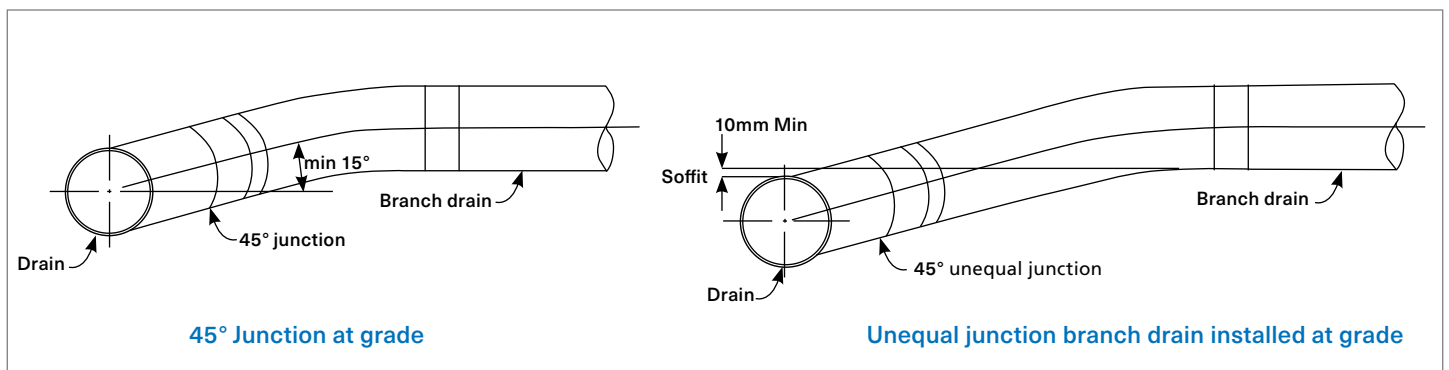

Above: Details from AS/NZS 3500.2:2021 Figure 4.9.1 — Typical arrangement for a graded branch drain entering another drain.



storey residences are suddenly scrambling to come to grips with the changes to the standard and are forced to reevaluate the design of the sanitary plumbing systems in their standard house models. Not only is there possibly additional fall required in the wet area floor forcing the invert of the branch drain to now be set lower, but the requirement for the 15° fall from the branch drain could force the outlet drain to be in excess of 100mm lower than pre NCC 2022.

This new requirement may cause the overall depth of the floor system to be increased in an attempt to accommodate the extra falls required in the sanitary plumbing within the floor system. Alternately, some

If you are in the business of designing upper floor systems, you will need to be more aware of the impact the provision of sanitary plumbing may have.

builders are opting to introduce bulkheads in key locations, dropped down ceiling in utility rooms where ceiling height is not so important, or a total redesign of the sanitary plumbing system to add more stacks, shorten runs or rearrange wet areas closer to the external walls of the dwelling.

If you are in the business of designing

upper floor systems, you will need to be more than ever aware of the impact the provision of sanitary plumbing may have on your design, with this consideration perhaps being the primary determiner of floor depth, not structural adequacy. **T**

Craig Kay is the national product engineer for Tilling.
For more information on this topic, contact Craig Kay and the Tilling engineers via email at techsupport@tilling.com.au



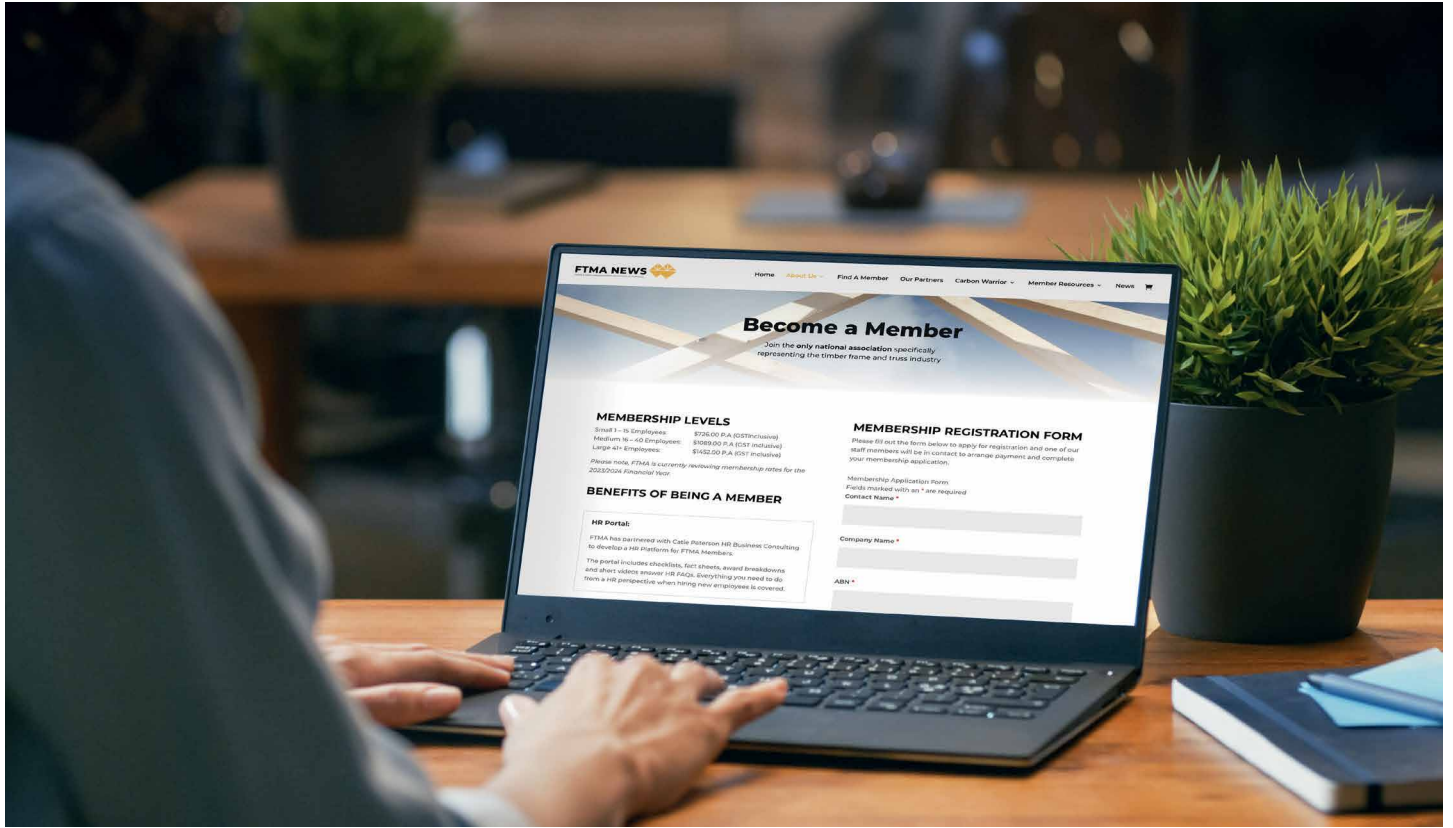

FATSO producing data we have NEVER seen!

This quarter's Frame and Truss Sector Overview has produced vital insights into the sector.
By Kersten Gentle

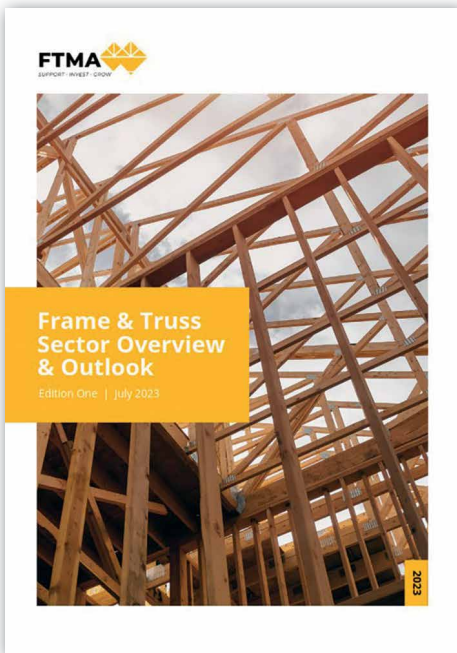

Above: FTMA members benefit from the sector insights contained in the 'FATSO' report.

FTMA Australia recognises that if we are learning anything as an industry it is that we are not just individual businesses operating as silos, but we are connected in our goals, projects, assets, and our difficulties. The purpose of researching and collecting data can bring us many insights into what we are all facing, as well as help us plan strategically, as individuals and as a collaborative, for the future.

FTMA has funded this research to directly benefit our members, and it is important to recognise that the FATSO report is a commercial product of FTMA Australia and our research partner, IndustryEdge.

We have decided to share the Executive Summary from the first edition of the Frame & Truss Sector Overview and Outlook produced by FTMA Australia. The full report is only available to FTMA Members as this project is costing the Association considerable funds.

Quarterly editions of the FATSO will be

produced for members. Each edition involves a reasonably large number of interviews conducted over a short period of time. The interviews are confidential, only the interviewer from IndustryEdge and the person being interviewed know what was discussed.

In fact, the only other person who knows who is being interviewed each edition is me.

Once interviews are conducted, the industry 'pulse' is linked up and analysed with the data that is available to understand what is happening in the supply chain, for fabricators, their customers and suppliers,

The real threats to our business lie outside that of healthy competition.

and to consider what might happen next.

Overall, the objective is to provide the sector and its entire supply chain with the best information about what is most likely to happen next.

A MESSAGE FROM FTMA CHAIR, AARON HILLMAN

For too long our industry has operated in a disjointed and fractured manner. The last few years have shown us that the real threats to our business lie outside that of healthy competition.

As a sector made up of approximately 280 plants, we are a metaphorical school of fish. All primarily focused on our own survival but unconsciously reliant on being part of something much larger. We respond to each other's reactions to market conditions and fight to get to the front of a collective group that is ultimately navigating blindly.

The FATSO reports look to give fabricators a source of information and opinion unavailable anywhere else. Collectively we can strengthen our industry, build for the future, and re-establish what our sector is valued for, "A bespoke, designed, engineered, manufactured product that is both sustainable and critical for the country's economy and social obligations."

FTMA is appreciative of our fabricator and supplier members who have participated in these interviews, providing their insights into our sector, which makes this report unique.

We also thank our members for respecting that this is a commercial product of FTMA Australia and our research partner, IndustryEdge, and thank them for not sharing outside of our membership.

Finally, without the support of our valued partners, we would not be in a position to produce this research, and we thank our partners, who are listed at the back of the document, for their outstanding support.

We hope you enjoy the executive and just a word, the full report is worth every cent of your membership, as this is data, which has never been available to our industry before, and will definitely help members and suppliers plan for the future.

EXEC SUMMARY

Second half of 2023 could be toughest ever as slowdowns, high input prices and cancellations take their toll.

As this first edition of FTMA's Frame and Truss Sector Overview and Outlook (FATSO

for short) comes out, there is deepening industry concern about cancellation of projects in the pipeline of housing work.

Industry feedback does not quite include a consensus, but there is a strong view that the second half of 2023 will become increasingly tough.

For builders, fixed-price contracts see them trying to exit unprofitable work, but for fabricators and others who have made commitments based on preorders, these are worrying times.

There has long been concern about the 'profitless boom' and now it seems, we're seeing the results of a lengthy period when there was plenty of work, but much of it was unprofitable, due to higher input prices. Little wonder there are quite a few builders struggling to make it through the current situation.

Inventories throughout the supply chain are higher than desired. There may not currently be an industry measure of inventory, but there are plenty of stories and no one interviewed for this first FATSO is having any trouble getting materials at the moment. Labour is another matter.

The market situation compounds the concerns of fabricators and the timber supply chain that the next few months and the early part of 2024 could be more than a little difficult.

As with most of these events and issues, the devil may be in the detail and that includes timing. Anyone who can pick the bottom and top of any market consistently is destined for greatness. It does seem very difficult right now to call the market.

In that context, new house sales and approvals may already have bottomed, if we look at the latest data. For a country with insufficient housing and looking to migration to solve major labour shortages, its vital to get more dwellings built, as early as possible.

Most interviewees talked up the role of Government in supporting the housing sector, and there are some looking for action on the new National Housing Accord as a means of getting the sector moving again.

In the absence of that, most consider the sector will be over-capacity, especially when steel's new capacity is factored into the total market. **T**



For more information contact FTMA on 0418 226 242 or via email at kersten@ftma.com.au



PRINCIPAL PARTNERS



STRATEGIC PARTNERS



SUPPORTING PARTNERS



For a full list of the conditions of membership and a downloadable application form visit:

www.ftmanews.com
BROUGHT TO YOU BY



PHOTO: COURTESY FTMA



Above: This tangle of services in the roof of an aged care home adds load that needs specific designs.

The Rime of the Ancient Engineer

Service loads in medical facilities require special thought.

By Paul Davis

I'm touched by the muse today, so let's jump straight in:

*I'm feeling poetic today,
I want to share my thoughts.
I want to tell you about my job,
And the roofs that I have wrought.*

*I have crawled in many roof spaces,
Seen the trusses and the rafters.
Braved dust and cobwebs hanging,
The stuff ups and disasters.*

*I have witnessed roof truss failures,
Cracks and splits and sags.
The damage from the weather,
The leaks and moulds and dags.*

And, over the years I have been in many nursing home and hospital roofs. One consistent theme is the startling number of services in the spaces. And sometimes there are truss failures associated with these loads.

Almost inevitably these facilities have fire sprinklers, because the patients and residents aren't mobile enough to evacuate themselves in the event of a fire. On top of

the potentially very heavy sprinkler services, we can have an absolute tangle of power and comms wiring that can be up to several kilos per square metre of weight. And then of course we have the aircon that we see so much in domestic buildings.

Check out the photo I took in an aged care home (above). I estimate that the average weight of all these services in the photo is about 25kg/m².

To possibly help you with future load estimates, Table 1 (below) is the approximate weight of a full metal water supply or fire service pipe:

Diameter (mm)	19	25	50	75	100	150
Weight (kg/m)	2	3	7	15	23	46

Table 1: A guide to estimating weights of metal water supply or fire service pipes.

So 25kg/m² in the photo, or something thereabouts roughly doubles the total weight of a metal sheet roof, ceiling and lining. It's about a third again on the weight of a tile

roof. If the roof wasn't explicitly designed for that load, it could be enough to cause it to fail – even if it doesn't fail it would be technically unsafe. And so:

*I have also seen the troubles,
Of more loads and stress.
The pipes and wires and vents,
That make the roofs compress.*

Just imagine how many plumbers and electricians have also passed through this area of the roof space over the years. Their weight combined with the service weights, would have well and truly found out any weaknesses in the trusses.

*I've seen the workers in the roofs,
The ones who like too much cake.
I've seen their cracks and hairy backs,
And wished they'd have less weight.*

*I've seen them pile on the roofs,
With pipes and tools and gear.
I've seen them strain the trusses hard,
And it made me shed a tear.*

For new jobs of this type, I highly recommend liaising early with the client about design for service loads. They will probably struggle to tell you exactly how heavy is the gear going in the roof space at the time you need to design the trusses. On top of those loads it wouldn't be a bad idea to make a provision for future loads. One option you might offer them, for a price of course, is to design a path through the roof through which all the major 'trunk' services pass and load that bottom chord panel appropriately in your design. That area might be loaded with say 50kg/m² and the rest of the roof at say 5-10kg/m² for services generally.

A good spot for the service trunk route would be the bottom chord panel under the apex – if you can narrow that panel span a bit you can limit the effect on timber sizes. And, of course, you would want some sort of signage or documentation to confine the main loads to these areas.

*You'd think I've seen it all, I tell you,
That there's nothing new to me
But still, I climb into
those roofs
And am amazed at
what I see!* **T**



Paul Davis is an independent structural engineer managing his own consulting firm Project X Solutions Pty Ltd. The views in this column are Paul's and do not reflect the opinions of *TimberTrader News*.
Phone: 02 4576 1555 | Email: paul@projectxsolutions.com.au

VEKTA PACKFEEDER

The ultimate automatic infeed system - speed, compact size, customisable and it completely eliminates picking errors.



VEKTA PACKFEEDER

The most common cause of downtime for an automated saw is a lack of timber on the infeed conveyors.

Feeding a linear saw can be a very labor-intensive process. Operators will fatigue and naturally slow down over the day and loading mistakes can cost a plant significantly in lost productivity. Vekta's Packfeeder solution addresses these issues in an extremely compact, clever manner - making it a viable option for both new and existing plants.

Packs of timber are loaded onto light-weight racks. Racks with longer timber are loaded on an upper row while those with shorter timber are loaded on a lower row. A vacuum head gantry then scans the location of each rack and the profiles of the timber in those racks. When called, a piece of timber of the correct length and grade is picked up with the vacuum head and delivered to the saw. **Vekta Packfeeder requires 75% less space than any other system.**



HUNDEGGER

• Compact • High Output • Maximum Yield

The TURBO-Drive 2

Scan the QR code to find out more:



For more info, contact Charlie Hutchings on +61 439 554 411 | cph@hundegger.com.au

Innovationen für den Holzbau